

NOV 1973

# BME

BROADCAST MANAGEMENT ENGINEERING

**NAB 1973**

**Unveils Significant  
New Equipment  
For Eager Buyers**



10-1  
N 2  
#7-01

4  
187  
180  
180  
180  
180  
180  
180  
180

KLINGSTON

# If You Want To Hear Something Great, Read This.

Stop by our booth at the NAB Convention in Washington, March 25-28, and listen to our pitch.

You'll hear it loud and clear on our new Scully 280B magnetic recorder/reproducer. (The 280B has, to our knowledge, the best signal-to-noise ratio in its price range.)

The 280B also has a new feature that lets you switch directly from "record" to "play" without stopping at "stop." And it has one, two and four channel capability.

We'll also demonstrate our new Metrotech 400 Series Logger and 4400 Time Code Generator. A new track format on the 400 lets you log twice as much programming on a standard reel of tape.

Which, simple mathematics tells you, can cut your tape costs by half.

So drop by Booth 614 in the Ambassador Room of the Shoreham Hotel.

While you're in Washington, we can go through channels together.

▶ **Scully/Metrotech**

*Division of Dictaphone Corporation*

Circle 100 on Reader Service Card



SEE US  
AT NAB  
BOOTH 317

# DYNAIR's price catalog describes these new products and over 150 others.

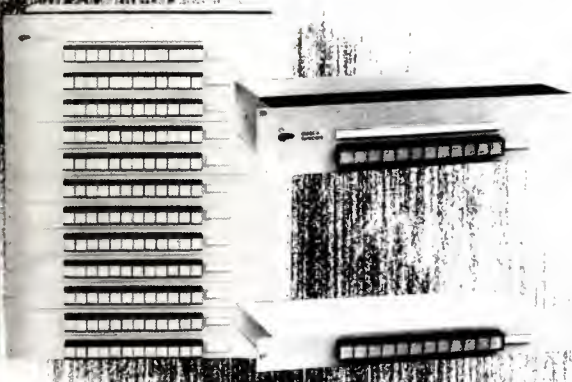

## NEW "PATCH CABLE ELIMINATOR"

DYNAIR's new Series-X Video-Audio Switchers eliminate the custom fabrication usually required for routing switchers. These units are totally modular, allowing off-the-shelf assembly of almost any input-output configuration, either video-only, or audio-follow-video. And, expansion is easy too . . . you simply add input or output expansion modules as required.

The basic unit is video only, with options including audio, sync-mixing and tally provisions. Illuminating pushbuttons are standard, with provisions for easily labeling the individual inputs and outputs. The new Series-X provides exceptional performance at prices which are, in many cases, much less than our earlier version of the Series-X.

## NEW SPECIAL EFFECTS GENERATORS

DYNAIR's new SE-70A and SE-70A-R Special Effects Generators allow basic effects to be easily and inexpensively added to any television system. These broadcast quality units operate equally well on color or monochrome signals, with either broadcast or industrial sync. A quality locking-type gear-driven effects mechanism is used, allowing effects to be easily implemented.

The units provide horizontal and vertical wipes, inserts from any corner with diagonal expansion, and internal and external keying and matting. The SE-70A is self-contained for console mounting and the SE-70A-R is an electrically identical remote-controlled unit, the control panel of which may be easily mounted in custom panels.



## NEW DYNAIR "PRICE CATALOG"

DYNAIR's new price catalog has been designed to provide you with a quick look at the large variety of equipment we manufacture and our current price on each item. We think that you will appreciate the convenience of this new catalog/price list combination . . . it's a very handy reference guide to DYNAIR's world of television.

Request your copy today . . . we think you'll like what you see.



## DYNAIR ELECTRONICS, INC.

6360 FEDERAL BOULEVARD  
SAN DIEGO, CALIF. 92114 U.S.A.  
TELEPHONE 714-582-9211

DYNAIR

Circle 101 on Reader Service Card

MARCH 1973/VOLUME 9/NUMBER 3



For the first time in several years some significant new equipment will be shown. Buyers won't exactly be bidding from the floor, but they have purchasing in mind. See article, page 31.

**BROADBAND  
INFORMATION SERVICES, INC.**  
274 Madison Ave.  
New York, N. Y. 10016  
212-685-5320

Editor

**James A. Lipcke**

Associate Editor

**Robin Lanier**

Contributing Editor

**M. L. H. Smith**

Assistant Editor

**A. E. Gehlhaar**

Art Director

**Gus Sauter**

Production Manager

**Arline G. Jacobs**

FCC Counsel

**Pittman Lovett Ford  
Hennessey and White**

Advertising Director

**Charles C. Lenz Jr.**

## 6 Broadcast Industry News

New AM-FM operator rules go into effect.

## 24 Interpreting The FCC Rules and Regulations

Rundown of operating rule changes effective April 4, 1973.

## 31 NAB-73 Unveils Significant New Products For Eager Buyers

Helical VTRs in limelight.

## 60 Buffalo: A Modern TV Plant Aids, And Shares In, Regeneration of Downtown Area

Both function and appearance of WGR-TV's new downtown plant add muscle to the city's bootstrap operation.

## 64 Eight Years of Updating End in a Final Splurge—Result Is A Completely Modern Stereo FM Plant

WWDL in Scranton kept adding to facilities, then put a new building right around the old one to hold it all.

## 68 Traffic Speeds Up and Station Personnel Slow Down As Computer Tie-Ins Solve Long-Time Problems

KOB-TV, Albuquerque, is happy with BIAS

## 72 The Competition Sounded Louder Than We Did—How We Met The Challenge

"Sound shaping" has to be used with discretion if a radio signal is to stay clean and also be "loud" enough.

## 76 Quick Success On The FM Band: Getting All Around Town Pays Off For New Station

Being johnny-on-the-spot for local happenings wins a strong following for WDDD-FM.

## 81 WCVB-TV, An All-Digital Station—No Other Way To Go

The initial shake-down period is rough, but it's worth it.

## 85 Broadcast Equipment

New and significant products for broadcasters

## 104 New Literature

Useful reading materials

## 108 New Books

## 110 Crosstalk

## 128 Editorial

CM/E MAGAZINE: For those with cable interests/Following page 84



BM/E, BROADCAST MANAGEMENT/ENGINEERING, is published monthly by Broadband Information Services, Inc. All notices pertaining to undeliverable mail or subscriptions should be addressed to 274 Madison Ave., New York, N.Y. 10016. BM/E is circulated without charge to those responsible for station operation and for specifying and authorizing the purchase of equipment used in broadcast facilities. These facilities include AM, FM, and TV broadcast stations; CATV systems; ETV stations; networks and studios; audio and video recording studios; consultants, etc. Subscription prices to others: \$15.00 one year, \$25.00 two. Copyright © 1973 by Broadband Information Services, Inc., New York City. Controlled Circulation postage paid at East Stroudsburg, Penna.





VIDEO VIGNETTES  
**NAB BOOTH 300**

THE GRASS VALLEY GROUP, INC. 

Circle 102 on Reader Service Card

[www.americanradiohistory.com](http://www.americanradiohistory.com)

# BROADCAST INDUSTRY NEWS

## FCC Relaxes Operator Rules For AM and FM Stations

In response to a petition from the National Association of Broadcasters, the Federal Communications Commission has partially relaxed the operator requirements for AM and FM broadcasters. Effective April 27, 1973, an assistant chief operator will be allowed to act as chief operator when the latter is absent. A second amendment makes partial proof of performance on directional antennas due every three years, rather than every year as at present, for stations without first-class radiotelephone operators on duty. The new rule requires only a skeleton proof of performance every year for such stations. The FCC, however, denied the NAB request for deletion of the requirement of automatic shut down if the antenna fails to switch properly, for stations using lesser-grade operators, pointing out that even if the automatic cut-off were not required, such stations would be required to shut down manually under Section 73.93(g) of the rules. (See also Interpreting the FCC Rules and Regulations, this month, page 24.)

## Ampex Sells VTRs to ABC Worth \$3.5 Million

Ampex Corporation announced a two-year agreement with the American Broadcasting Company for delivery of videotape recorders and cassette video systems with a potential value of about \$3.5 million. The first three AVR-1 VTRs have already been delivered to ABC in Hollywood, and the first three ACR-25 video cassette systems will be delivered in April 1973, according to the announcement, two in Hollywood and one for San Francisco.

## WWCC Forfeits \$3000 For Contest Rigging

The FCC has ordered AM Station wwcc, Bremen, Georgia, licensed to

Bremen Radio Company, to forfeit \$3000 for violation of Section 509 (a) (4) of the Communications Act, by prearranging the outcome of a contest with intent to deceive. According to the FCC, wwcc in November 1971 broadcast a contest in which no more than one person could win per day, but led listeners to believe that a person might win on any of the broadcasts of the contest, even after another person had won on a particular day. The FCC rejected the management's request that the forfeiture be reduced because of the small income of the station, pointing out that the station's financial condition had been taken into account in setting the amount. The station management did not avail itself of its right to an evidentiary hearing.

## FCC Refuses to Drop Cross-Ownership Rules

In answer to a number of petitions for reconsideration of the prohibitions against cross-ownership between TV broadcasters and cable

system operators, the FCC has affirmed its bans against joint ownerships as specified in Section 76.501 of the rules. The Commission said it had given thoughtful consideration to the petitions, but remained persuaded that the bans "are in the public interest and should continue in force." The goals of the rule, said the FCC, are "increased competition in the economic marketplace and . . . in the marketplace of ideas." The major broadcast networks are already so dominant in television, said the FCC, that any further expansion of their control should be "stopped and turned around before it becomes entrenched." The Commission did, however, extend the deadline for divestitures required under the rule to August 10, 1975—the deadline had been August 10, 1973.

## FCC Opens Major Inquiry Into Relations of Hotel-Movies Cable, and Broadcast Systems

The Federal Communications Com-  
continued on page 8



ABC's Julius Barnathan, vice president in charge of broadcast operations and engineering (left), and Arthur Hausman, president of Ampex, signing the \$3.5-million agreement for AVR-1 recorders and ACR-25 cassette video systems at ABC's headquarters in New York City.



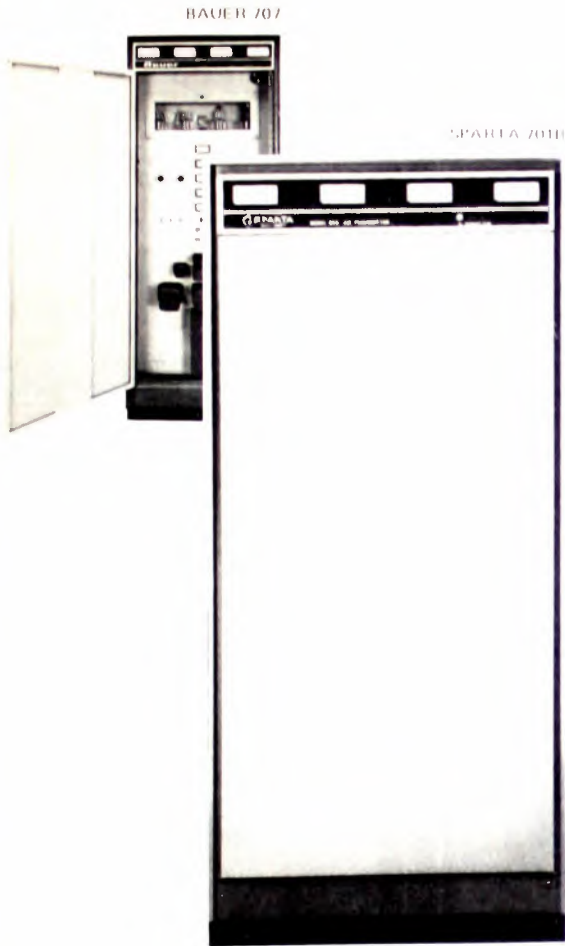

the Bauer 707 was 'just right' in 1960

THE SPARTA BAUER 701B IS 'JUST RIGHT' TODAY

In the tradition of the most successful broadcast transmitter in history, the Bauer 707, now comes the SPARTA 701B:

- All solid state, right up to the finals
- 125% positive modulation
- Tally light overload indicators
- New long-lived 4-500 tubes

Plus these and other time-tested SPARTA/Bauer 'just right' quality features; oil filled modulation transformer, built-in dummy load, vacuum capacitor final tank tuning.

**THE NEW MODEL 701B SPARTA/1kw AM TRANSMITTER IS THE ONLY ONE MANUFACTURED TODAY WITH EVERY ONE OF THESE 'JUST RIGHT' FEATURES AS STANDARD EQUIPMENT!**

SPARTA, the 'just right' company . . .  
small enough to be first name friends . . .  
big enough to supply EVERYTHING. Call us. Collect.



**SPARTA**  
**ELECTRONIC CORPORATION**

5851 Florin-Perkins Road, Sacramento, Ca. 95828  
916 383-5353 TELEX 377-488 CABLE SPARTA  
A DIVISION OF COMPUTER EQUIPMENT CORPORATION

*Booth 310, Sheraton-Park Hotel, Washington, during the NAB Convention*

Circle 103 on Reader Service Card

**15 day free trial shows you why ITC tape cartridge equipment is an industry leader.**



**SP SERIES REPRODUCER**

A two week test in your own broadcast facilities is the only fair way for you to evaluate the performance of ITC's premium line cartridge equipment. Advertising statements are no longer simply claims, but become actual facts proven first hand. Find out for yourself how ITC has built in all the features demanded by broadcasters since tape cartridge equipment was invented. If ITC equipment fails to measure up, you're under no obligation. You'll find that ITC dependability is something on which you can rely completely.

**RP SERIES RECORDER/REPRODUCER**



**Call us collect to arrange a 15 day free trial 309-828-1381**

**INTERNATIONAL  
TAPETRONKS  
CORPORATION**  
2425 South Main Street,  
Bloomington, Illinois 61701

Circle 104 on Reader Service Card

**NEWS**

mission has opened an inquiry looking toward rulemaking that could have major effects on the competition brewing among the movie-for-pay systems going into hotels and motels, cable systems, and television broadcasters. The inquiry was stimulated by a complaint of Sterling Manhattan, cable operator in lower Manhattan, against Trans-World Communications, which is furnishing movies-for-pay to New York hotels, using the closed-circuit video transmission service of the New York Telephone Company. Columbia Pictures, parent of Trans-World, has also applied for permission to use microwave in the Business Radio Service to distribute motion pictures to hotels in four other cities. Related also, said the FCC, are the proposed rules for licensing and regulating common carrier stations in the Multipoint Distribution Service.

The FCC, pointing out that a basic question is whether and to what extent any of the new services should be restricted to prevent unfair competition with broadcasting or cable, refused to rule immediately on the Sterling complaint against Trans-World and allowed Trans-World to proceed. However, the FCC did say that while the rulemaking was underway it would consider requests from cable systems for waivers allowing them to compete with transmission firms in supplying motion pictures to hotels and motels; cable systems could proceed with assurance that such waivers would be granted in "competitive situations." The review, under Docket #19493, will cover broadly the many interrelated questions raised by the new services, said the FCC, inviting comments by May 31, 1973.

**Task Force on Renewal Law Opens Campaign**

The Task Force on License Renewals of the National Association of Broadcasters opened a country-wide campaign to encourage enactment of broadcast license renewal legislation in the 93rd Congress. Task force captains in each of the 50 states were working with broadcasters in their areas "assigned" to each of the 535 members of Congress. The plan also includes participation by State Associations, working with community leaders, and a vigorous public relations pro-

gram. Committee chairman Mark Evans said: "Much spadework has already been done in Congress . . . The committee has developed strategy and a plan of action . . . but make no mistake, neither NAB nor this committee can do the job. Our success will depend on broadcasters."

**Arizona CATV Elects Officers**

The Arizona CATV Association, at its meeting December 14, 1972, elected Don Corbitt, of Cobre Valley Cablevision, Miami, Arizona, president for the coming year; Clay Blanco, of Valley Telecasting, Yuma, as vice president; and Morris Wright, of Cable-Com General, Safford, as secretary-treasurer.

**NAB Says Pay Cablecasting Will Erode Free TV**

Unrestricted pay cablecasting, the NAB said in a recent statement, will erode the widespread availability of free TV. The danger, said the NAB, is that pay programming will siphon off free TV's programming supply, forcing free TV into a downward spiral with consequent loss to the public; and thus anti-siphoning regulation "no longer can be postponed." Antisiphoning would increase, not decrease, program diversity, said the NAB, by forcing cable operators to come up with new programming.

**AECT Plans Convention in April in Las Vegas**

The Association for Educational Communication and Technology has announced its plans for a convention to be held April 8-13, 1973, at the Las Vegas Convention Center. Sessions will cover many aspects of educational technology, including both theoretical and practical approaches. Not only schools and colleges, but government, industrial, medical, and other special branches will be represented. Audio and video techniques, including films, video cartridges and telecommunications, will be covered. An exhibit of equipment in the field is a feature of the meeting.

**NCTA Asks For Convention Technical Papers**

The engineering department of the National Cable Television Association has issued its annual call for continued on page 10



1.

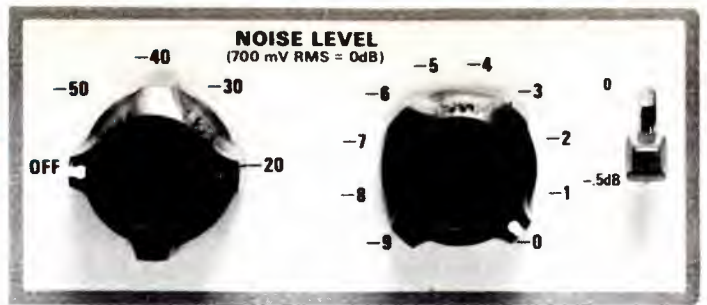

*easy*

2.

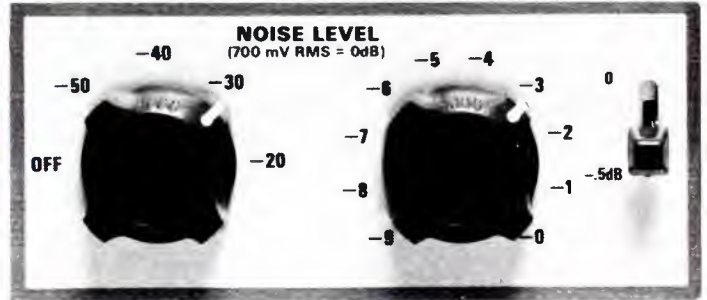

*in-service*

3.

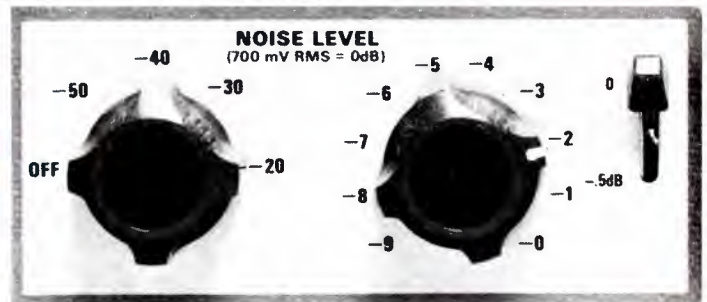

# noise measurement



## the TEKTRONIX 1430

It's **easy** to make in-service or out-of-service noise measurements with the TEKTRONIX 1430 Random Noise Measuring Set. An error-free, side-by-side comparison technique is used. **1.** A portion of a line is deleted. **2.** A calibrated noise level is then inserted by the TEKTRONIX 1430. **3.** The noise level to be measured and the 1430's calibrated noise output are then matched side-by-side on a waveform monitor or scope. This method is highly accurate. In-service noise measurements, using a

selected line in the vertical interval, are made with better than 2-dB accuracy. And the measurements are meaningful in terms of what you see on a picture tube because CCIR weighting and low-pass filters are built in.

Accurate, repeatable measurements are convenient to make in cameras, VTR's, STL's transmission systems or wherever video-frequency random-noise is a problem. Of course program material is protected with copper-to-copper safety. Tests

Circle 105 on Reader Service Card

can even be performed in the absence of composite sync using the 1430 generated horizontal sync. Full-field measurements can be made with resolution approaching 0.5 dB. For more information about the Tektronix noise measurement technique, contact us at P.O. Box 500-A, Beaverton, Oregon 97005.



*in Europe —*  
**TEKTRONIX LTD**  
Guernsey, C.I., U.K.

**TEKTRONIX®**

committed to  
technical excellence

For demonstration:

Circle 106 on Reader Service Card

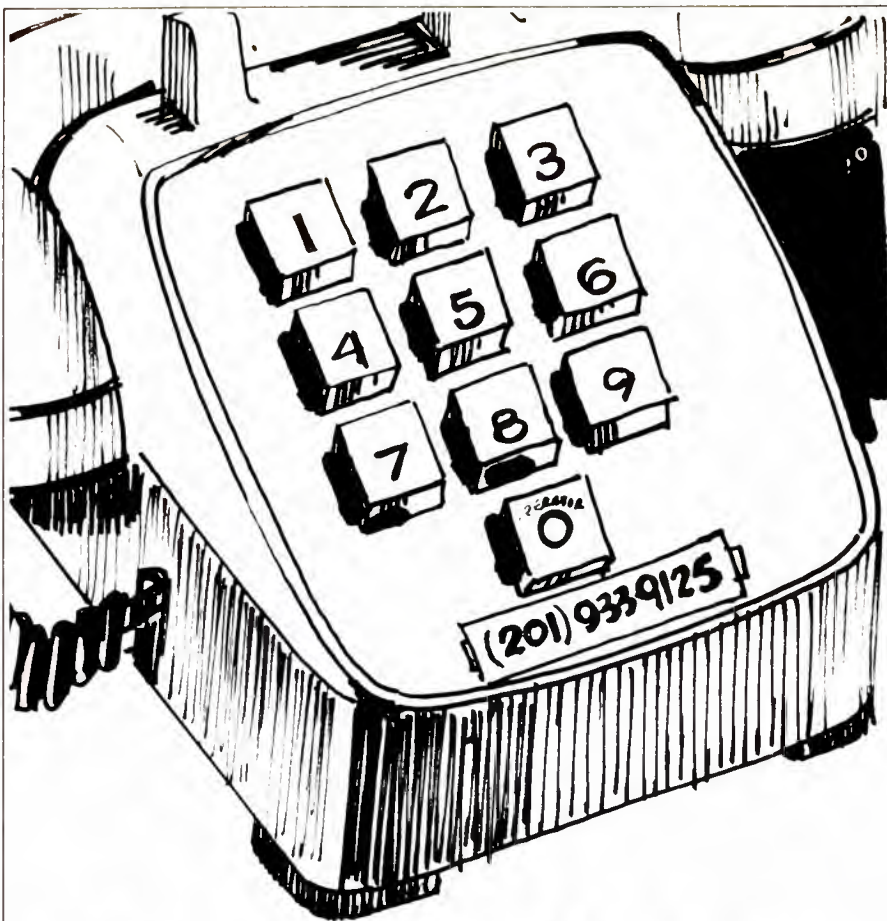

# Panic Buttons for Video Tape Reels

Whenever you run out of video tape reels, it's always the worst possible time. When you can't do anything but panic.

Call us.

We have every size reel you need, ready to go: 1/2", 1", 2". They're made of rugged Plio-Magic to resist bending, cracking, breaking, even under impact. They're competitively priced.

Next time you get in a bind on video tape reels, hit our panic buttons: 201-933-9125. We'll give you the fastest service in the business.

Send for our new Video Tape Catalog today.

## PLIO-MAGIC®

Plastic Reel Corporation of America  
 Subsidiary of Williamhouse-Regency Inc  
 Dept N3 640 South Commercial Avenue  
 Carlstadt, New Jersey 07072



Circle 107 on Reader Service Card

## NEWS

technical papers for the Convention, to be held June 17-20 in Anaheim, California. Advance indications are for more than 5000 registrants and more than 150 exhibitors. Among the topics specially wanted are those in the area of program origination, cable channel allocations, measurement and tests, subscriber terminals, microwave and laser systems, interactive systems, technical manpower and management, satellite/cable systems, installation and maintenance, and many others. Those wanting to submit a paper should send a one-page (150 word) abstract no later than March 1, 1973, to Delmer C. Ports, NCTA, 918 16th St. N.W., Washington, D.C., 20006. Those whose papers are accepted will be notified by April 1, 1973.

### TPT Washington Report Enlarged to Half Hour

Excellent viewer response stimulated TelePrompTer Corp., New York cable system, to expand its weekly cable program, "Window on Washington," from 15 minutes to a half hour beginning in January. The program is prepared and moderated by Anne Denton Blair, the cable industry's first full-time Washington correspondent. Mel Baily, TPT executive producer, says the longer program will allow greater depth and story development, and will also integrate better into programming of others among TPT's 96 systems in other cities.

### FCC Extends Date For Cable Performance Tests

Acting on a plea from the National Cable Television Association, the FCC at the end of the year extended to December 31, 1973 the deadline for reporting of the initial performance tests required of all cable operators. NCTA had pointed out the severe shortage of equipment and trained personnel, and the heavy financial burden of the tests for smaller cable operators. On the latter point, the FCC opened, under Docket #19659, an inquiry into possible changes or amendments in the rules that would ease the smaller operator's burden, with comments due by February 28, 1973. The FCC, noting the hundreds of service complaints received every year, pointed out that any amendment must be consistent with its objective

continued on page 12



Automatic monitoring

Digital effects with programmable wipes

Animated logos

Preselected wipes

Preselected keys

"Mini" digital effects

Wipeable quad split with matted borders

Rotary effects

Variable wipe limits

Edged effects with chroma borders

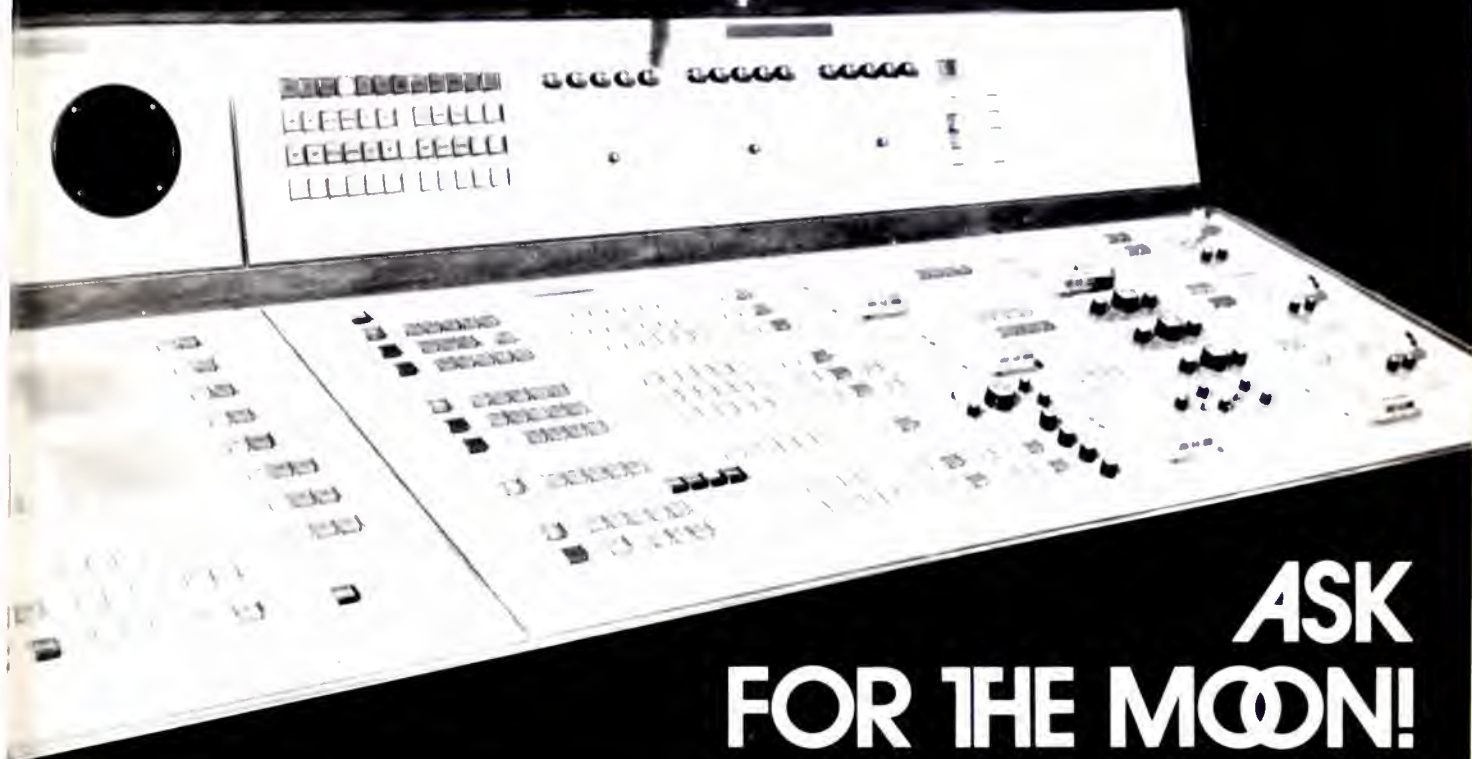

# ASK FOR THE MOON!

**Bill Kessel did. And got it.**

Just ask him. He's one of the toughest chief engineers in the business. And he wanted features that no one else could give him in two switchers for his studios at KTVT in Ft. Worth and for his facilities in Dallas.

Jack Harris, the production manager, was just as delighted... on the creative side. He got the exclusive features that pack in business... with a control board designed for guys who have to put it all together.

Take a shot at the moon... everything you want... and then some. See us at the NAB Show!



Sarkes Tarzian, Inc.  
Broadcast Equipment Division  
Bloomington, Indiana 47401

Circle 108 on Reader Service Card

# STILL LOOKING FOR THE RIGHT TIME-BASE-CORRECTOR?

1000 TR-4 825 7900 7800  
TR-5 7800 960 TBC 320F

VO1600

DP-3

870

3650

VCR-100

1100

5800



## Look No Further!

SEE IT ALL AT NAB BOOTH 600,  
AMBASSADOR ROOM, SHOREHAM HOTEL

### DELTA Series TBC Systems

Interface to all kinds of VTRs — Broadcast Quads — 1" Helicals —  
½-inch EIAJ Portables — ¾-inch Cassettes.

### DELTA 44 MODULAR TBC SYSTEM

Five optional models with built-in proc amp — Field Convertible to  
work with low-cost VTRs in mono and color, with new Delta 28 TBD™  
— and Delta 36 HETRO COLOR™ Modules.

### DELTA 47 — PIC-PROCT™ TBC SYSTEM

Time Base and Velocity Error Correction down to the proverbial  
Gnat's Eye — in one 7-inch standalone rack package.

### DELTA 7 — VELCORT™ HUE SHIFT CORRECTOR

Standalone Velocity Error and Color Jitter Corrector — add one to  
your quad or heliscan VTR already equipped with its own internal  
TBC.

Write or phone for catalog, technical specs, and the name of your nearest  
demonstrator equipped distributor.



**TELEVISION MICROTIME, INC.**

A SUBSIDIARY OF ANDERSEN LABORATORIES, INC.

1280 BLUE HILLS AVE. • BLOOMFIELD, CONN. 06002

Tel. (203) 242-0761 • TWX 710-425-2390

Circle 109 on Reader Service Card

## NEWS

of assuring reasonable service to every cable subscriber.

### WBTV Gets Record Amount of Blood for Red Cross

Stations WBTV and WBT in Charlotte, North Carolina, in a campaign organized jointly with the Red Cross, gathered 1126 pints of blood from volunteer donors, the largest quantity ever collected in a single day in North Carolina. The "Give-In," in the WBTV studios, used 33 donor tables, operated by nearly 300 volunteer medical and non-medical helpers, with the scene put on the air from time-to-time along with announcements urging citizens to come in. The WBTV "Give-In," the announcement says, is the major reason the Piedmont Carolinas' chapter of the Red Cross has not suffered a blood shortage in recent years.

### 3M Forms National Dealer Network

The 3M Company has set up a national network of 14 professional audio dealers for the company's audio recorders and accessory equipment. Included are: Accurate Sound, Garland, Tex.; Aengus Enterprises, Fayville, Mass.; Audio Recorders of Arizona, Phoenix; Automated Processes, Melville, N.Y.; F.T.C. Brewer, Pensacola, Fla.; Fidelity Sound, Washington, D.C.; Daniel Flickinger, Hudson, Ohio; Gill Custom House, Palos Hills, Ill.; High Fidelity Showroom, Clayton, Mo.; Jackson Sound, Denver, Col.; Maze Corporation, Birmingham, Ala.; Pams, Dallas, Tex.; Telephase Electron systems, Memphis, Tenn.; and Westlake Audio, Los Angeles, Calif.

### TIO Finds Minority Hiring Far Up In Broadcasting

In answer to charges by Dr. Everett Parker of the United Church of Christ that broadcasters have a "dismal" record in the hiring of minorities, Roy Danish, director of the Television Information Office, has pointed out that during 1971 and 1972 minority employment in broadcasting has risen sharply in all nine major full-time occupational categories. "Dr. Parker ignores the rapid progress in minority hiring . . . during the last five years, and even his use of statistics is warped," said

continued on page 14



# Now hear this:

EIMAC super-power tetrodes provide transmitter "building blocks" up to 10.4 megawatts, 100% modulated.

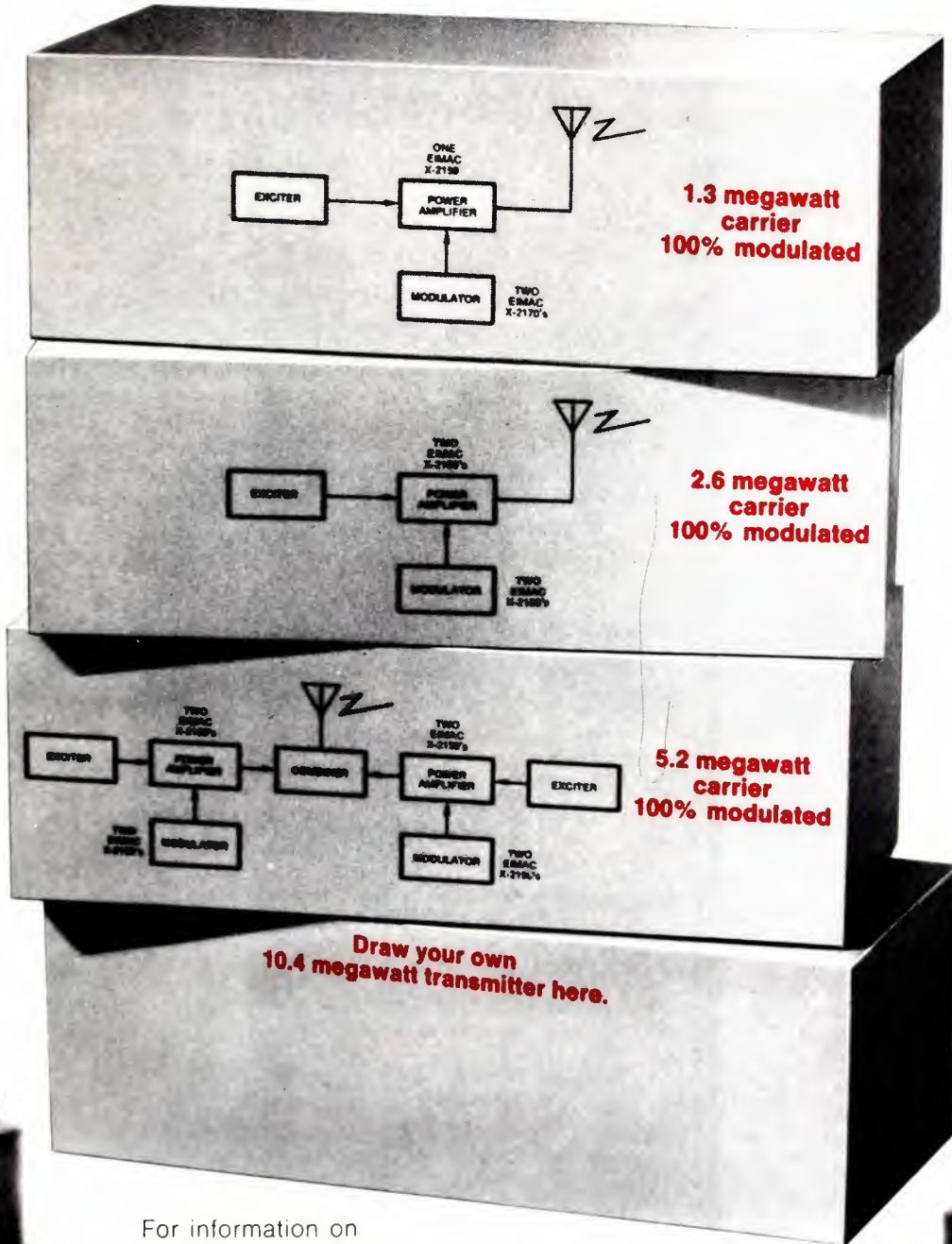

X-2159



X-2170

For information on the X-2159 and X-2170 super-power tetrodes, contact the EIMAC Division of Varian, 301 Industrial Way, San Carlos, California 94070. Or any of the more than 30 Varian/EIMAC Electron Tube and Device Group Sales Offices throughout the world.



Circle 110 on Reader Service Card



Dear Gabby:

# "How can a wife compete with a \$10,000 Video Tape Editing System featuring Jam-Sync?"



Datatron's Girl Gabby

**DEAR GABBY:** My husband returned from the NAB show singing the praises of a \$10,000 Video Tape Editing System which features something called 'Jam-Sync'. Since he seldom praises my homemade jams, or notices the hours I slave over the kitchen sink, I need help in winning him back.

**DEAR NEGLECTED:** Many NAB visitors fell in love with Datatron's Model 5050 - a Video Tape Editing System with keyboard entry which works with helical or quadruplex VTRs, yet is priced at \$10,000, thousands under competition. In fact, a number of TV stations placed orders right at the show.

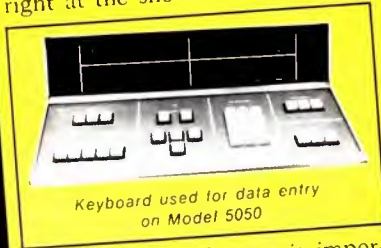

Keyboard used for data entry on Model 5050

The jam-sync feature is important since it eliminates the need to pre-record the SMPTE time code on tapes for add-on editing from masters or live sources.

Instead, during pre-roll, the built-in time code generator is set & sync'd so that time picks up exactly where it left off - to the

frame! This saves hours of time, and head wear on expensive video recorders too.

But don't fret. Once your husband's Datatron Model 5050 is installed, he'll have more free time to sing the praises of your jams and jellies.

GABBY

★ ★ ★

**DEAR GABBY:** How can Datatron sell a SMPTE edit code reader for \$1500 and a generator for \$1750 when competitive models go for over \$2500?

**AFRAID OF BARGAINS**

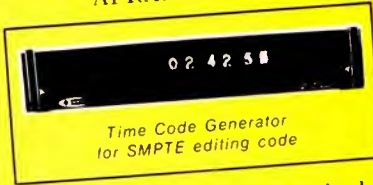

Time Code Generator for SMPTE editing code

**DEAR AFRAID:** Don't be afraid of these bargains. Datatron's edit code reader & generator are fallouts from their Video Tape Editing System project. The low prices reflect simple construction and dedicated design. Actually, they cost less than capstan revolution counters which aren't nearly as accurate.

GABBY

★ ★ ★

Send your questions - either straight or humorous - to Gabby. We'll mail a Flair pen for all received and pay \$100 if we use question in future ad.

## datatron inc.

1562 Reynolds Ave / Santa Ana, Calif. 92711  
(714) 540-9330

moving up fast in...



Automatic Test Systems



Microelectronic Testing



Timing Instrumentation



Shelly Indicators and Readouts

Circle 111 on Reader Service Card

## NEWS

Mr. Danish. "He reports, for example, a one-percent increase in . . . officials and managers . . . (actually) this is one percentage point (and the increase) was 25%." Mr. Danish said a TIO survey has shown that, in 27 of the largest cities, 38 of every 100 broadcasting jobs filled during 1972 went to a member of a minority group.

### Public Issues Get N.Y. Airing Thru Regional Plan Programs

A comprehensive series of programs on public issues, with the general title "Choices for '76," is in preparation by the Regional Plan Association, independent New York study group, for presentation during 1973 on most of the New York television stations. One-hour programs on housing, transportation, environment, poverty and other problem topics will run over several three-day periods, with one program on each of the 18 TV stations in the area. Study papers on the project will appear in a book; newspapers are adapting the material to feature stories. The viewing public will be asked to "vote" on the issues, with the Gallup organization making a before and after study of the vote results.

### NAEB's Harley Says CPB Should Stay Out of Programming

President of the National Association of Educational Broadcasters, William G. Harley, has issued a statement contending that only an agency directly responsible to licensed stations should have a decisive influence on programming, since the legal responsibility for the programming rests with the stations themselves. Therefore, says Mr. Harley, the Corporation for Public Broadcasting, since it is accountable to the government, should have no operational role in programming.

### Kodak Sets Full Schedule of Motion Picture Courses

Eastman Kodak Company has announced a 1973 schedule of courses in motion picture and color film technology, to be held through the year in Rochester, San Francisco, Dallas, Atlanta, New York, and Oak Brook, Illinois. Among the courses offered are Basic Film Production, Advanced Film Production

continued on page 16



# VIDEO TAPE Problems

Why wait until a video tape problem arises before buying a **RECORTEC**? Start saving by joining the hundreds of satisfied users of our equipment.

## VIDEO TAPE CONDITIONER



- Extends tape and head life by removing loose oxide and debris from tape surfaces.
- Improves quality of video recording due to reduced dropouts.
- Minimizes tape damage by improving the tape pack.
- Options such as erase, splice count, audio playback, etc., are also available.

PRICE \$4450

## VIDEO TAPE EVALUATOR



- Display total number of edge damages.
- Display total number of surface defects.
- Display total tape time.
- Tape fully cleaned, uniformly packed and degaussed.
- Increases VTR utilization.

PRICE \$7500

UPGRADEABLE

# RECORTEC, INC.

777 Palomar Street • Sunnyvale, California 94086 • (408) 735-8821

Circle 112 on Reader Service Card

When  
Engineering Excellence  
creates a more  
functional design,  
it creates the  
AEL 25KW FM  
Transmitter.

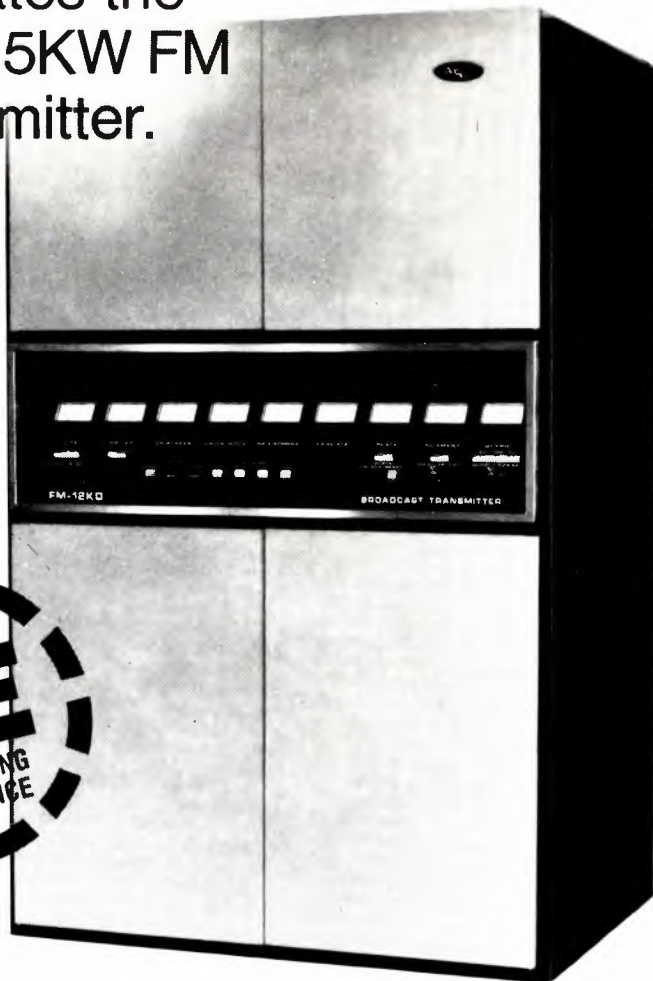

AEL's engineering excellence has once again created new concepts in functional design which integrate ease of operation with better reliability for a new high in transmitting performance.

Engineered for automatic operation, with designed-in quality and solid state control circuitry, the FM-25KD Transmitter proves that engineering excellence is an everyday quality at AEL.

Let it be an everyday quality at your station. Contact AEL to see the advanced design capabilities of our entire "EE" Transmitter Line.



See us at Booth 215  
NAB CONVENTION  
March 25-29, 1973  
Sheraton Park Hotel  
Washington, D.C.

**A**ERICAN **E**LECTRONIC **L**ABORATORIES, INC.

P. O. Box 552, Lansdale, Pa. 19446 • (215) 822-2929 • TWX: 510-661-4976 • Cable: AMERLAB

Circle 113 on Reader Service Card

## NEWS

tion, Sound and Double Application, Ektachrome Processing, Eastman Color Negative II Workshop and others. Complete schedule and all other information can be had at Eastman Motion Picture Division regional offices in Dallas, Atlanta, Hollywood, San Francisco, New York, and Oak Brook, Ill., or at Eastman Kodak, 343 State Street, Rochester, N.Y. 14650.

### Smooth Sound Puts Down Rock Music, Says Gavin

Smoother sound is taking over, with less than 25% of the top-100 hit singles in 1972 belonging in the hard-rock category, according to an annual summary released by the Gavin Report. America seems to be going for mellow ballads, says Gavin. Country music and rhythm and blues continued to thrive, according to the survey.

### NAB Executive Committee Endorses Code Board Changes

The Executive Committee of the National Association of Broadcasters has endorsed a major reorganization of the Radio Code program, intended to increase membership in the Radio Code. Under the new plan the Code would be applicable to all NAB members, who would certify their adherence on an annual basis. The cost of Code operations would be met from general NAB funds; members not adopting the Code would get no reduction in dues. Further, the Radio Code board would be directed to devise a code reflecting the industry's "high standards and general principles," assuring broad industry support.

### NAB Affirms Free-Press Rights of Broadcasters

The Board of Directors of the National Association of Broadcasters has adopted unanimously a resolution affirming the right of broadcast journalism to protection under the First Amendment to the Constitution, which guarantees freedom of the press. "We further affirm that . . . freedom of the press from government interference at any level is fundamental to our free society, to the public's right to know, and to broadcasting's responsibility to the public to inform them accurately and objectively," the resolution said

continued on page 18



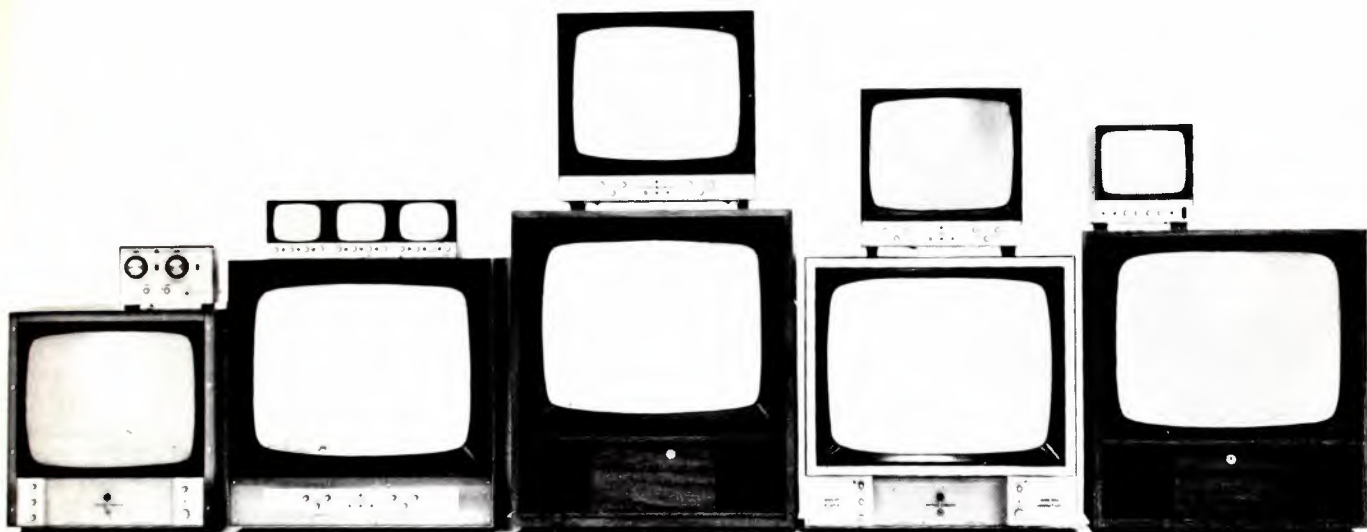

# NEW FAITHFULS

The Setchell Carlson reputation for **QUALITY** and **RELIABILITY** is demonstrated over and over in every S.C. Electronics monitor and monitor/receiver with features such as plug-in circuit modules (pioneered by S.C. to assure operating dependability and ease of maintenance); 100% solid-state circuitry for maximum stability, long-life, low power drain, and a minimum of heat; up to 640 lines horizontal resolution; and regulated circuitry that provides extremely stable operation while preventing raster size or brightness deviations due to line voltage fluctuations.

Available in a broad line of screen sizes, Setchell Carlson products lack only one thing... a high price. Whatever the application, broadcasting, CCTV, Medical training, industrial TV applications, custom remote installations, industry, education, or many others, Setchell Carlson has the monitor you need.

Ask about them today at your nearest S.C. Electronics dealer, or write for full information and descriptive literature.

ALSO ASK OR WRITE FOR INFORMATION AND FULL-COLOR LITERATURE ON OUR QUALITY COLOR MONITORS



**SC ELECTRONICS, INC.**  
A SUBSIDIARY OF AUDIOTRONICS CORPORATION  
530 5th AVE. N.W. ST. PAUL, MINNESOTA 55112  
PHONE (612) 633-3131

Circle 114 on Reader Service Card

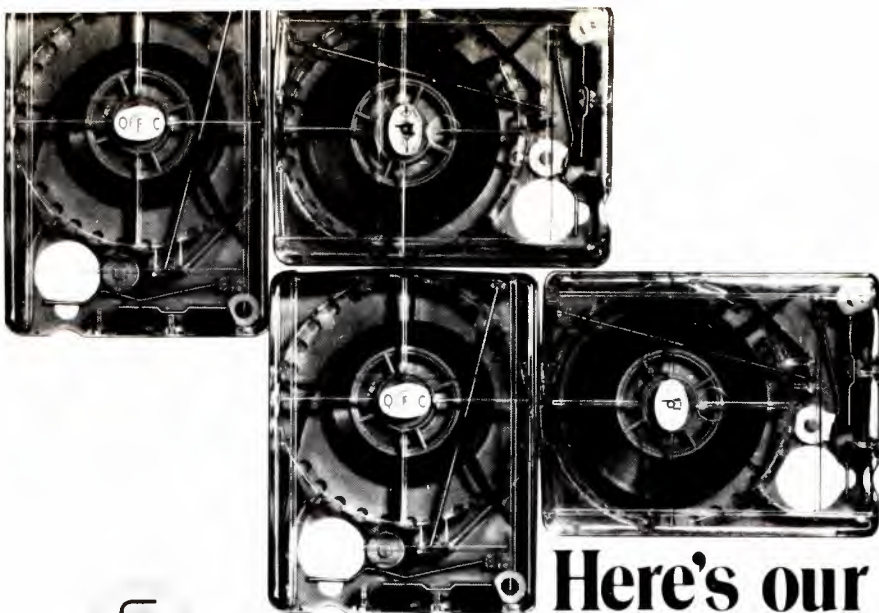

## Here's our story...

Want more? Contact your Fidelipac Distributor and learn why more Fidelipac Automatic Tape Cartridges are in use throughout the world than all others combined.

# FIDELIPAC®

3 Olney Avenue • Cherry Hill, New Jersey 08034 • (609) 424-1234

*Fidelipac is a registered trademark of TelePro Industries Incorporated*

See us at NAB, Booth 511, Shoreham Hotel  
Circle 115 on Reader Service Card

At **DSC** we would like  
to sell you test slides  
...but we can't!

It's against "Company Policy"

"Company Policy" states that the accuracy and integrity of DSC test materials must be beyond question—that DSC slides incorporate current industry standards—that DSC slides only be distributed on a lease basis and that they be analysed regularly and substandard slides removed from circulation.

When you think about it, our "Company Policy" is in your company's interest.

- Simple display for fast efficient line up
- Dye images of telecine have similar spectral characteristics to programming materials
- Economical — supplied on lease basis
- Free replacement — broken or damaged slides replaced at no cost.

For more information, please contact  
DSC Test Slides,  
D and S Corley Limited,  
80 Galaxy Boulevard, Unit 3,  
Rexdale, Ontario, Canada, M9W 4Y8

When in Toronto, visit our new Laboratory by the International Airport.

Circle 116 on Reader Service Card

## NEWS

in part. It also urged the NAB government relations staff to exert every effort toward obtaining legislation which would assure broadcasters of the protection.

### NCTA Opens National Awards Program

A 1973 National Awards Program, announced by the National Cable Television Association, will include awards in five categories for cable systems: System marketing campaign; public relations, single project; public relations, continuing campaign; advertising and promotion, single project; advertising and promotion, continuing campaign. Entries must be based on projects or activities conducted between April 15, 1972 and April 13, 1973; the latter is the 1973 entry deadline. NCTA will make the awards at its 2nd Annual Marketing Workshop in Denver, May 10-12. Entry blanks: NCTA, 918-16th St., N.W., Washington, D.C. 20006.

### Mountain Broadcasters Elect Morgenroth President

The Rocky Mountain Broadcasters Association, at a meeting on January 9 in Salt Lake City, announced the election of Earl E. Morgenroth as president. Mr. Morgenroth is president of Western Broadcasting Co., Missoula, Montana, which operates television and radio stations in seven cities in Montana and Idaho. Vice presidency of RMBA went to Bill Sims, of KOJO Radio, Laramie, Wyoming.

### Founder's Project Issues History of Cable in Massachusetts

The Founder's Annex Public Service Project has issued "Cable in Mass 2," an updating of an earlier handbook on cable. It includes a history of cable in Massachusetts; the status of cable in each municipality; each company's ownership and record; and an annotated copy of the state regulations. Copies: \$3.50 each, plus 80 cents for first class mail, 40 cents for second class, from Founder's Annex, P.O. Box 388, Dedham, Mass. 02026.

### Westinghouse Gives Studio Building To Temple University

A seven-story building in downtown Philadelphia, used for 34 years as  
continued on page 20



# COMPUTER-ASSISTED REMOTE CONTROL

FULLY DIGITAL  
CONTROL — TELEMETRY  
STATUS—AUTOMATIC LOGGING

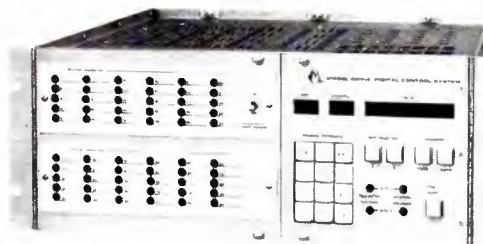

MODEL DCS-2



Computer option: up to 30 parameters displayed simultaneously, tolerances on all channels . . . even totally automated transmitter operation.

---

## AURAL STUDIO - TRANSMITTER & REMOTE PICK-UP LINKS



### SYSTEMS FOR

- 148—174 MHz    ■ 215—240 MHz
- 300—470 MHz   ■ 890—960 MHz
- Others on special order

New models RPL-3 and RPL-4 compact remote pick-up systems for 160 MHz and 450 MHz . . .

For the international AM broadcaster, the new model PCL-101 STL for 148-240 MHz . . .

And all the time-proven Moseley STL's.

---

## ANALOG REMOTE CONTROL

Stepperless 15-channel model TRC-15A. Pushbutton model PBR-30A. Both systems available for wire and wireless service.



See us in Booth 313, Sheraton Park, during the NAB, or write for details.



MOSELEY ASSOCIATES, INC.  
SANTA BARBARA RESEARCH PARK

111 CASTILIAN DRIVE  
GOLETA, CALIFORNIA 93017  
TELEPHONE (805) 968-9621  
TELEX 658448

Circle 117 on Reader Service Card

an origination site for area and national radio and television programming, has been given by its current owner, Westinghouse Broadcasting Company, to Temple University. The building had been used until mid-1972 by the Westinghouse stations, KYW-TV and KYW Newsradio, and for the Mike Douglas Show, all now in a new building on Independence Mall. Temple will set up a number of classrooms in the building, and also use the studio facilities for laboratory programs in theater, radio, and television.

### Perry of GE Hails Outlook for 1973

Donald E. Perry, vice president of General Electric and general manager of its home entertainment division, predicted at year's end a 6% to 7% increase in consumer electronics business in 1973 over the high levels set in 1972. He saw audio systems and components up about 15%, reflecting in part a reduction in average living space that makes component systems look more salable than the older consoles. His projec-

tions on TV receiver sales were for about 8.5 million color and 8.3 million monochrome units, roughly the same as in 1972. Compactness and styling will be even more important than in the past, said Mr. Perry, with strong markets for portables. He said four-channel stereo should grow steadily, but will not replace two-channel for some time yet; evolution, not revolution, was his word for it.

### National Science Foundation Funds Tech Study in Tacoma

An experiment in joining engineers and systems experts with city administrators to seek new solutions to a wide range of city problems is underway in Tacoma, Wash., with funding from the National Science Foundation. The "Urban Laboratory" project is attacking such subjects as improved fire-fighting techniques, harbor protection, transit service, refuse collection, traffic case scheduling, and city government.

### Videorecord To Distribute Training On New Health Law

The Videorecord Corporation announced a videocassette series of

training programs on occupational safety and health, designed to aid industry in complying with the new Federal Occupational Safety and Health Act (OSHA), now being enforced by the U.S. Dept. of Labor. Dr. James Lieberman, vice president of Videorecord's medical division and formerly U.S. Assistant Surgeon General, called OSHA, effective in April 1971, "... the most sweeping legislation of its type ever passed by Congress." The eight-part videocassette series is available for rent or purchase at Videorecord dealers across the country.

### Greater Media Adds Two Stations To Broadcast Chain

Greater Media, Inc., of New Brunswick, N.J., announced purchase of WQTE, AM station in Monroe, Mich., and of WHFI, FM station in Birmingham, Mich. The multiple-station owner already operates stations in Washington, D.C., area, Huntington, W. Va., New Brunswick, N.J., Huntington and Smithtown, Long Island. The firm also publishes a chain of suburban newspapers in New Jersey and operates cable systems in New England.

continued on page 114

## ALL OF YOUR SYSTEM EQUIPMENT REQUIREMENTS CAN BE MET BY LENCO ELECTRONICS



### UNIVERSAL POWER SUPPLY

### VIDEO DISTRIBUTION

Our video D.A. is adaptable. The basic amplifier has plug-in accessories to provide:

- Differential input
- Equalization
- High gain
- Breezeway clamp
- Sync adder

You can change accessories with your changing requirements.

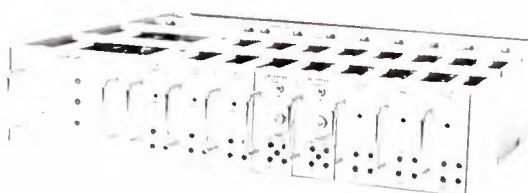

### SUBCARRIER DISTRIBUTION

Regenerated Subcarrier  
Continuous phase control of all four outputs  
Independent phase control of two outputs  
Loop-thru input  
Output amplitude adjustable 0-3 V.P.P.

This unit is actually two cascaded D.A.'s

## LENCO ELECTRONICS

A DIVISION OF LENCO, INC.

319 WEST MAIN ST.  
JACKSON, MO. 63755

PHONE 314/243-2394 OR 243-3141

### UNIVERSAL MOUNTING FRAME ACCEPTS UP TO 8 D.A.'S

### PULSE DISTRIBUTION

Our pulse D.A. is adaptable  
**Basic Amplifier:**

- Loop thru input
- Regenerates pulses at their half amplitude width
- Input level 0.5 to 8.0 V.P.P.
- Output amplitude 4.0 V.P.P.  $\pm$  5%

### Plug In Delay Accessory

- One control delays both leading and trailing edges
- Delay 250  $\eta$  sec. to 60  $\mu$  sec.

Write for our complete catalog

Circle 118 on Reader Service Card



# IT'S PRODUCT RELIABILITY

THAT MAKES  
**RICHMOND HILL  
LABORATORIES**  
EQUIPMENT SUPERIOR.

SEE OUR EQUIPMENT  
DEMONSTRATIONS AT  
BOOTH 319, NAB '73.



Engineers expect product reliability. That's why it's built into every RHL product.

At the NAB Convention, our feature demonstration will be the newest addition to our family of VPM Series Video Switchers. Model VPM-41.

The VPM-41 is a new, low-cost, 10-input, 4 bus Video Production Switcher with colour broadcast specifications. The unit utilizes an integrated control panel and electronics assembly to maintain its compact size, portability, and ease of maintenance.

*BE SURE. BUY PRODUCT RELIABILITY. SPECIFY...*



## **RICHMOND HILL LABORATORIES INC.**

142 Central Avenue,  
Clark, New Jersey — 07066

**EASTERN U.S.**  
142 Central Ave.  
Clark, N.J. 07066  
(201) 381-5955  
Telex 138245

**MIDWEST U.S.**  
370 Nottingham Lane.  
Hoffman Estates,  
Ill. 60172  
(312) 882-4622

**CANADA**  
1240 Ellesmere Rd.  
Scarborough, Ont.  
M1P 2X4  
(416) 291-7921  
Telex 02-29803

**ENGLAND**  
Pinewood Studios  
Pinewood Rd.,  
Iver, Bucks  
SLO ONH  
Telex 847505

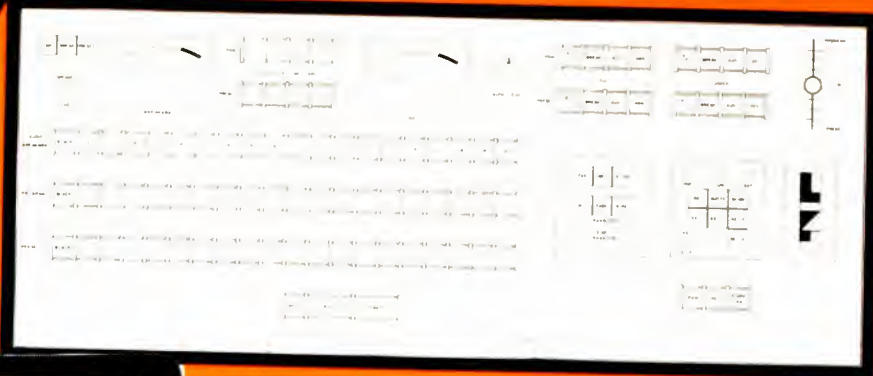

# the Vital way to tv automation

- New modular computer concept
- Extremely versatile, fast and reliable
- Easy operation with no computer training
- Standard and custom formats available
- 64 characters per line
- 27 events displayed at one time
- Full editing capabilities
- Multiple pre-rolls without time restrictions
- Full transition capability including fades, dissolves, pattern wipes and inserts
- Complete logging facilities for management and FCC purposes
- Manual override always "hot"
- Power failure protection
- Complete plant communications with auxiliary monitors
- Full spectrum of equipment can be controlled in any configuration and quantity
- Events on-air — by real, elapse, duration or cue time, plus manual
- Two automation systems in one: on-air plus 8 programmable selections for microwave switching, VTR's into record, etc.
- Optional mass data storage available for advanced scheduling from 27 events to one year

Several stations in America now enjoy daily use of the Vital Automation System. Write for your brochure describing our VIMAX-27 system.

Make Vital Industries, Inc. your single responsible source for your total system needs.

3620 Ridgewood Rd., N.W., Atlanta, Ga 30327  
404/233-9459

7960 W. Beverly Blvd., Los Angeles, Calif 90048  
213/653-9438

2644 N. Seventh St., Terre Haute, Ind 47804  
812/466-3212

GOOD ENGINEERING IS VITAL



**VITAL INDUSTRIES, INC.**

MAIN OFFICE: 3814 S.W. Archer Road, Gainesville, Fla 32601 — Phone 904/378-1581

Circle 120 on Reader Service Card



**We'll have  
news  
for you  
at  
NAB\***



\*See us at Booth 208

Circle 121 on Reader Service Card

# NEW

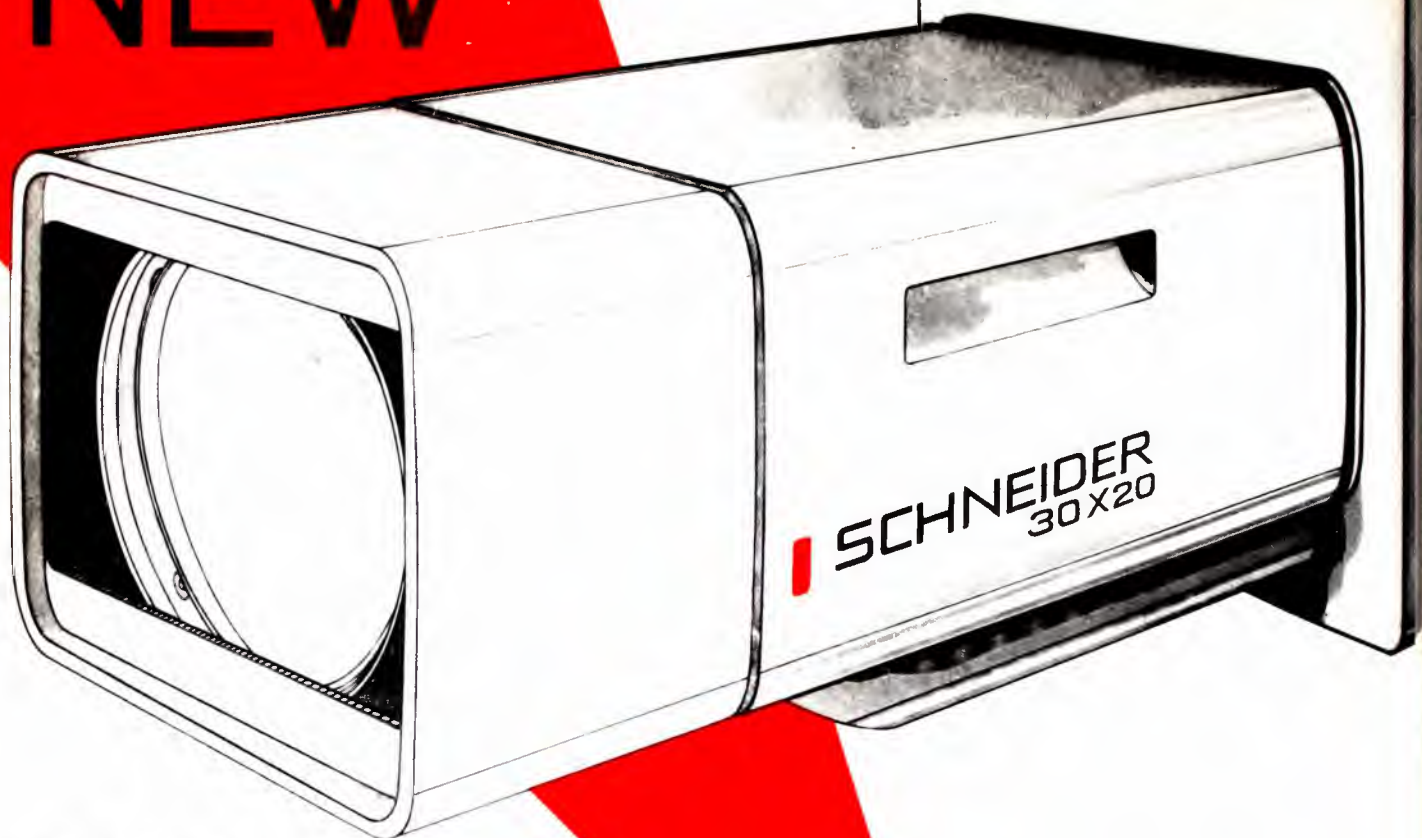

## THE SENSATIONAL 30x ZOOM



COLOR TELEVISION CAMERA LENS

**20 to 600mm, f2.1 for 1 $\frac{1}{4}$ "**  
**16 to 480mm, f1.7 for 1"**

PAT. PEND.

- CONTINUOUS 30x ZOOM
- FOR STUDIO OR FIELD
- COMPACT AND LIGHT WEIGHT CONSTRUCTION
- PATENTED SCHNEIDER MODULAR CONTROL SYSTEM
- SEE IT AT TELE-CINE INC. **NAB** BOOTH 537 – SHOREHAM HOTEL

### TELE-CINE INC.

294 East Shore Drive, Massapequa, N.Y. 11758  
Telephone: (516) 798-2828

Circle 122 on Reader Service Card



# INTERPRETING THE **FCC** RULES & REGULATIONS

## **Broadcast Re-Regulation: Changes In Certain Station Reporting, Record-Keeping and Operating Requirements**

In a recent broadcast action, the Commission changed and/or eliminated certain operating rules which it considered anachronistic. "Designed to remove unnecessary operating burdens and improve public service" these rule changes are individually minor in nature, but in the aggregate will save time and be more convenient for licensees and permittees. The minor rule changes pertain to the following: 1) auxiliary transmitter testing; 2) station reporting; and 3) operating requirements and record keeping.

*These rule changes become effective on April 4, 1973.*

### **Auxiliary Transmitters**

The requirement that auxiliary transmitters be tested at least once a week at a specified time has been lifted. Hereafter, the necessity of and time for testing is in the *discretion* of the licensee. Note: Though voluntary, all auxiliary transmitter tests must be entered in the maintenance log. Hence, the licensee need only specify that the auxiliary transmitter is 1) in proper operating condition, and 2) adjusted to the licensed frequency (if, of course, such is true) and used accordingly.

Because many auxiliary transmitters have a licensed power less than that of a regular transmitter, the Commission has determined that such an auxiliary transmitter (with lower power than the regular) may be operated in excess of the auxiliary's licensed power so long as it does not exceed 105% of the regular transmitter's licensed power.

In conformance with the rule applicable to AM stations, the Commission eliminated its "five-day restriction without FCC authority" on use of auxiliary transmitters for both FM and TV. Under special circumstances (e.g., when a licensee or permittee, for reasons beyond his control, must operate with 1) less than specified minimum operating power, or 2) less than minimum hours of operation), the

licensee is no longer required to notify the Commission or FCC district field office immediately of same to be given his ten-day grace period. Rather, he may submit to the Commission a *written request*, no later than the tenth day, for such additional time needed. Hence, the licensee has a ten-day grace period to correct the problem.

Clarification is made of the AM and FM rules which require the operator on duty to have ready access to and visibility of the transmitter, required monitors, metering equipment and/or remote control instruments. For purposes of picking up deviations from these instruments' normal indications, they must be visible for operator observation *within a 360° arc*. This eliminates the assumption that said instruments must be "directly in front" of the operator.

### **Station Reporting**

Licensees need no longer notify the FCC Engineer in Charge of the radio district of station location re the following:

- a) defective modulation monitor;
- b) defective indicating instruments;
- c) defective frequency monitor;
- d) maintaining minimum operating schedule;
- e) maintaining minimum operating power;
- f) departure from regular schedule of share-time operation;
- g) beginning of stereophonic broadcasting;
- h) transmission of point-to-point messages during emergency operations.

Note: Notification of the above to the Commission is required and operation without such equipment is limited to 60 days without further Commission authorization.

continued on page 26

# A NEW FAMILY OF ONE-GUN RACK-MOUNT COLOR MONITORS FROM

**unimedia**



**UNIMEDIA SMT-12 COLOR MONITOR**  
\$795

Not just one model, but a whole family of studio quality color monitors specifically engineered for broadcast, closed-circuit, cable and teleproduction applications. The inherent simplicity of the single-gun Sony Corporation Trinitron® picture tube eliminates convergence problems and more for brighter, sharper pictures.



**UNIMEDIA SMT-17 COLOR MONITOR**  
\$995

All models are available with switch control underscan, A-B input selection and pulse-cross display (optional). Each SMT chassis is constructed of heavy gauge aluminum and all primary controls are front mounted. Optional built-in audio speaker/amplifier is available on all models. SMT-9 is also available in dual and single half-rack versions.

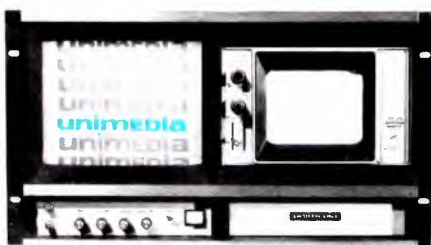

**UNIMEDIA SMT-9/528 COLOR MONITOR**  
\$745

**unimedia**  
**unimedia**  
**unimedia**  
**unimedia**

28971 HOPKINS, HAYWARD, CA 94545  
PHONE: (415) 782-2600

**UNIVERSAL MEDIA CORPORATION**

## FCC Rules & Regulations

continued

### Operating Requirements and Record Keeping

Certain other minor operating rules were *eliminated*, including the following:

- 1) The requirement that the licensee keep specifications concerning temperature variations at the crystals used in transmitters;
- 2) The requirement that he retain an accurate circuit diagram (furnished by the manufacturer of the equipment) at the transmitter;
- 3) The requirement that a supply of spare tower lamps be maintained;
- 4) The requirement for an entry in the operating log of each interruption, not automatically restored, of the carrier wave, covering the cause and duration of same and signature of the person restoring operation.

These are all *eliminated*.

In addition, the Commission made certain changes and clarifications in other minor operating rules, including the following:

- (1) The licensee may keep equipment performance measurement data on file at either the remote control point or at the transmitter. Note: The signator of the required material must also *date* it;
- (2) The licensee need no longer file, with the Engineer in Charge of the radio district of station location, the copies of contracts with part-time, first class radio-telephone operators;
- (3) An *exception* to the requirement that transmission live meter readings be entered in operating logs of FM and TV stations is made when power is being determined by the indirect method.

As presently drawn, Commission rules allow *unattended* operation of intermediate stations in multi-hop configurations in the aural services and for TV intercity relay stations, TV translator relay stations, and multi-hop TV STL stations, but do *not* provide for unattended operation in certain single-hop situations. Hereafter, the rules will permit *unattended* operation of one-hop aural STLs, aural intercity relays, and TV STLs. Of course, observations at the receiving end of the circuit are still required.

Commissioner Richard Wiley currently supervises a special task force considering a plethora of subjects for future FCC re-regulation action. This list of subjects includes directional antennae; remote pick-up; automatic transmitters; logging, program and operating maintenance; operator testing; Subsidiary Communications Authority; selected aspects of radio license renewals; reorganization and reformulation of FCC rules; administrative requirements; records to be filed with the Commission; records to be filed at the stations; reports to the FCC; application forms; other forms; and FCC and licensee communications and relationships. Many of these will likely become the subject of future formal proceedings. When such occurs, *BM/E* will treat changes in depth.

**BM/E**

Circle 123 on Reader Service Card



# WILKINSON HAS EVERYTHING



AM TRANSMITTERS - 250 W  
1 KW - 5 KW - 10 KW - 50 KW



LIMITERS - Mono and Stereo



AGC AMPLIFIERS - Mono and Stereo



REMOTE AMPLIFIERS



FM TRANSMITTERS 10W - 50W  
250W - 1 KW - 2.5 KW - 5 KW  
7.5 KW - 10 KW - 20 KW - 40 KW



MONAURAL CONSOLES

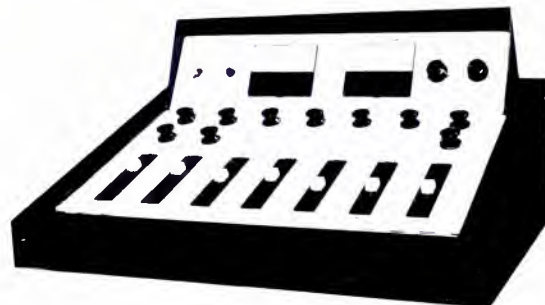

STEREO CONSOLES



FM EXCITERS



STEREO GENERATORS

AND ALSO FROM WILKINSON . . . AM RF Amplifiers, line surge protectors, AM Monitors, field intensity meters, line amplifiers, monitor amplifiers, distribution amplifiers, FM receivers, antenna tuning units, phasers, dummy loads and silicon rectifiers.

**WILKINSON**  
**ELECTRONICS, INC.**

1937 W. MacDADE BLVD., WOODLYN, PA. 19094

TELEPHONE (215) 874-5236/874-5237

Circle 124 on Reader Service Card

# The New CP-16/A (with Crystasound

RADIO 970  
POST OFFICE BOX 1000

WAVE  
LOUISVILLE KENTUCKY 40201

TV CHANNEL 3  
(502) 585 2201

October 6, 1972

Mr. Norman L. Bleicher  
Operations Manager  
Victor Duncan, Inc.  
11043 Gratiot Avenue  
Detroit, Michigan 48213

Dear Norm:

Thank you for your letter of September 13, 1972.  
You mention four areas for information relative to news work, using the CP-16/A, and they are as follows:

1. I feel that the CP-16/A is the best news camera on the market today. All of our news reporters feel the same way. It is extremely portable and we are able to shoot pictures much as we do with our Bell & Howell or Bolex cameras. I have designed a small "U" shoulder pod of aluminum, padded with rubber, for use with the camera. The light weight of the camera, "U" pod and magazine make for quick and easy shooting, with comfort and ease for the cameraman as well.
2. As to use under adverse conditions, the camera has performed very well in inclement weather and I see no reason why it should not be the same in the winter as in the summer.
3. Service has been the best. Both you and Cinema Products Corporation have been in close touch with us and we are very pleased with the quick service we are getting.
4. News of Interest: In addition to the shoulder pod, I have installed a Sennheiser MKH-815 shotgun microphone, with a shock-proof mount, on top of the CP-16/A camera. The camera is so quiet that the 815 mike does not pick up any camera noise. With no cables and no power pack to get in the way or restrict your movement, the cameraman can really move in and around, getting the right position to get the best picture. He becomes a part of it all.

The enclosed photographs may be of some help to explain the "U" pod and the shotgun mike. The cameraman is Larry Sales, a reporter here at WAVE News. The other guy holding the camera and mike happens to be me.

In summing up, I am happy to say that we are very pleased with our two CP-16/A cameras (even the price) and I am looking forward to getting another in the very near future.

Sincerely yours,

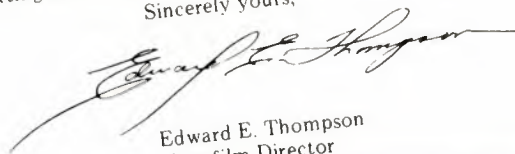

Edward E. Thompson  
Newsfilm Director  
WAVE-TV

EET:jk  
Enclosures



LOUISVILLE,  
KENTUCKY  
WAVE-AM-TV

EVANSVILLE,  
INDIANA  
WFIE-TV

GREEN BAY,  
WISCONSIN  
WFRV-TV

ESCANABA,  
MICHIGAN  
WJMN-TV

CEDAR RAPIDS-  
WATERLOO, IOWA  
WMT-AM-FM-TV

Mr. Edward E. Thompson,  
Newsfilm Director,  
WAVE-TV





# Cameraman's Kind of Camera.



Mr. Larry Sales, TV-Newsfilm Cameraman, WAVE-TV



To arrange for a demonstration of the all new CP-16/A (with Crystasound recording system) or CP-16 cameras, contact your local professional sales/rental dealer.



CP-16



CP-16/A

For further information, please write to:

**cinema E products**  
CORPORATION

*Technology In The Service Of Creativity*

2044 Colner Avenue, Los Angeles, California 90025  
Telephone: (213) 478-0711 ■ Telex: 69-1339 ■ Cable: Cinedevco

Circle 125 on Reader Service Card

[www.americanradiohistory.com](http://www.americanradiohistory.com)

# Our Proc/Amp and DOC cure the helical-VTR-blues. Also the reds and greens.

If the only thing bothering you about your helical VTR is the picture you play back, you can relax.

Because with the 3M Processing Amplifier and 3M Dropout Compensator on-line, you can virtually rebuild your tapes with any helical format, in monochrome or color.

Our P-100 proc/amp corrects for high or low contrast, inaccurate or washed-out colors and picture jump or roll.

It replaces the original sync and blanking with EIA-format sync, while our SYNC GUARD circuitry gives you a rock-solid picture even with distorted or industrial sync. It provides dc restoration and removes tilt and bounce. Clips white and black levels and clamps the video signal to reduce noise and transients. Gives you full front panel control of burst amplitude and phase, video and chroma level, sync and set up. And optional plug-in modules are available for video and chroma AGC and color regeneration.

If you've got more problems, add our D-100 Dropout Compensator (DOC). It replaces lost video information with fill-ins perfectly matched for luminance and chrominance, with no lines, no flashes, no color mis-



matches. Video stability and full color interlace are maintained even through multi-generation dubs.

And while it does all this, our DOC reduces your system costs by allowing more passes on your tapes because it corrects for dropouts due to wear, while its built-in dropout simulator allows system test without the expense and inconvenience of a test tape.

So whether you use them as stand-alone units or as a complete video processing system, our proc/amp and DOC don't just give you a better picture: they help pay for themselves.

And that could solve another problem.

Video Products, Mincom Division, 3M Company, 300 South Lewis Road, Camarillo, California 93010. Telephone: (805) 482-1911. TWX: 910-336-1676.

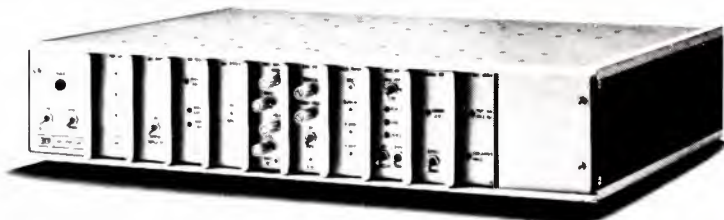

**We've been there.  
And brought the answers back.**

**3M**  
COMPANY

Circle 126 on Reader Service Card



# NAB '73 Unveils Significant New Equipment For Eager Buyers

LAST YEAR AT NAB CONVENTION TIME the economy was on the upturn. This year it's practically booming. A sampling of managers and chief engineers surveyed by *BM/E* indicates high interest in new equipment and greater attendance in Washington than in Chicago last year. And, for the first time since the introduction of the video cartridge player in 1969, there will be some significant new equipment unveiled to allure buyers. *BM/E* has already had a peek at several impressive new systems and undoubtedly a few surprises will be unveiled at the show.

IVC is headlining a helical VTR multiple cart machine as a low-cost way to achieve VTR automation. A new company (new in broadcasting, that is), Echo Sciences, is unveiling a broadcast quality helical back-pack recorder. Marconi is bringing over from England a brand new telecine which reflects a total redesign effort. As evidence that we are truly into the digital era, Sarkes Tarzian is ready to amaze us with a digital effects generator. And there are some new advances in automatic measuring and correcting equipment as the following pages will illustrate.

Prospective buyers will be there according to *BM/E's* second annual "Panel of 100" survey\* which measures the degree of interest in the NAB Convention, and in new equipment in particular. All signs indicate more pointed interest in specific product areas and greater attendance.

\*Several panels of 100 were surveyed. Breakdown of respondents: TV (plus TV with radio interests), 68; radio only, 64. TV respondents were preponderantly directors of engineering (managers turned their questionnaires over to engineering executives for completion). Radio respondents were: managers or owners, 38; chief engineers, 26.



New portable one-inch helical VTR from Echo Sciences meets full broadcast requirements.

In response to the key question—"Will you be looking at any specific new equipment?"—86% said "yes." We found that virtually every TV broadcaster is looking for some specific piece of equipment. Seventy-seven percent of the radio broadcast group is looking for something in particular for expansion purposes (50%) or for replacement (50%).

In the TV area, the video cartridge/video cassette machine is of keenest interest; 70% said this equipment would be investigated. Next in order of interest are cameras. Sixty percent of this group is most interested in medium-priced cameras as opposed to top-of-the-line (40%). Portable cameras were identified as being of special interest.

A product to move from relative obscurity last year to high on the

interest list this year is the videotape editor. Last year 25% expressed an interest. This year almost half have a specific need for editing equipment.

Also high on the list are video switchers, including automatic switchers. Although the total number of panelists showing interest in TV transmitters and remote control equipment has waned some what, transmitters are *the* piece of equipment of most interest to about one-third of the respondents.

In the realm of radio, three products stand out as being of more than usual interest: audio consoles, cartridge players, and automation in general. Consoles lead the list with 65% of our respondents mentioning specific interest in them. But the real winner in terms of increased interest over last year is automation equipment. Last year



40% singled out automation, but this year the figure is 52%. Our breakout shows cartridge machines of keen interest—61%. There is no comparable figure for last year since we then lumped this popular product with tape recorders in general.

We also note that logging equipment and status and alarm indicators have moved up in interest this year, due doubtlessly to FCC rule changes.

Tables showing various categories indicate shifts in interest.

## Greater attendance

In 1973, 70% of our respondents (from a cross-section of both large and small stations) indicate they are making the trip to Washington. Last year it was 66%. Those with TV interest will be there in greater numbers (82% said "yes" compared with 77% last year). And, in five cases out of six, if a panelist said he was not attending, his station will be represented by one or more staff members. (The only TV station replying which did not expect to attend at all was a small public TV station.) Our poll indicates 56% of those with radio interests only will be attending—just slightly better than last year. Two-thirds of all managers replying are going, but only about three-eighths of the engineers.

## More money but buying may be deferred

Those that will be attending have bigger budgets than they did in 1972. The average budget\* for TV stations, represented by our panel for 1973 is \$380,000 per station compared to \$300,000 last year. For radio, the capital expense budget is \$33,450 up considerably over the \$25,000 reported last year.

Although broadcasters will be seeking out specific products and will have money to spend, there is likely to be very little buying directly on the convention floor. Last year some 9% indicated they might buy at the show; this year only two or three broadcasters thought they might sign up at the convention. Most indicate they'd do their actual purchasing later in 1973.

\* Thirty-two TV stations and 20 radio stations provided budget estimates.

## Overall Interest In TV Equipment

	Percent Interested 1973	Percent Interested 1972
Video Cartridge/Cassette	70%	—
VTRs	50	60
TV Cameras (med. price)	33	} 80
TV Cameras (top of line)	24	
Character Generators	50	50
Videotape Editors	45	25
Switchers	42	50
Audio Consoles	33	—
Film Chains	33	43
Test Equipment	33	—
Automation	30	37
Remote Control Gear	30	50
Monitors	30	40
Enhancers	30	43
Transmitters	27	43

## Overall Interest In Radio Equipment

	Percent Interested 1973	Percent Interested 1972
Consoles, Mixers	65%	60%
Cartridge Players	61	} 65
Tape Recorders/Players	52	
Automation Equipment	52	40
Audio Processing	42	55
Headsets	35	37
Remote Pickup & STL	35	25
Status & Alarm Indicators	35	—
Loggers	33	25
Microphones	33	52
Turntables	33	57
FM Transmitters	30	40
AM Monitors	28	32
FM Monitors	28	29
FM Antennas	26	43
Audio Controls	26	—
Transmission Lines	24	23
AM Transmitters	17	20
Towers	11	20

## Portability and High Performance in New VTR From Echo Science

The combination of easy portability with high performance is obviously needed to expand out-of-the-studio service for the VTR. Echo Science Corporation is showing a new one-inch VTR system. The WR201C, in a compact package, designed for easy back-packing or van shelf use; total weight with rechargeable battery is 38 pounds, dimensions 15 in. x 11.5 in. x 6.5 in. The recording format is the two-head helical system introduced by Echo Science, which has a scan angle of 13 degrees and track length of 3.7 in. The new unit has a tape speed of 15 ips, writing speed 1470 ips, record time one-half hour on standard 8-in. reel. Electronics is high-band, NTSC color direct. The system has been used in literally thousands of airborne missions of the U. S. military.

Echo Science is also showing the WRR411C, a studio model using the same format as the WR201C (recordings are interchangeable between the two machines). The WRR411C is a table-top model weighing 140 pounds, with overhead bridge holding

picture, waveform, and audio monitors. Playing time is one-and-one-half hours on 12½ in. reel. Continuous time and velocity correction is integral. Inputs are provided for composite video (0.5 to 1.5 v p-p), sub-carrier, composite sync, and black burst. Specs meet broadcast standards. Price about one-half that of quad.

## Two New Systems Pioneer Automatic Video Correction

Send a video color signal down a long transmission line, or through a satellite "circuit," and a lot of things can happen to it. Up to now, getting a color signal back to standard has depended on manual adjustment at the receiving end of the line.

Now come two units designed to keep a video signal completely up to snuff automatically by monitoring the Vertical Interval Reference signal (VIR), and applying instantaneous correction as needed.

In a pre-NAB disclosure exclusively for *BM/E*, CBS Laboratories announced the introduction at the show of the VIR Correction System, a two-

continued on page 34



# Yesterday's Prophet and today's Profits

DYNASCIENCES  
"PROFIT PROPHET" PREDICTS  
THE YEAR OF THE  
NEW AUTOMATICS

*Michelangelo's "MOSES" CA. 1513 - 1515, S. Pietro in Vincoli, Rome*

## Automatic Image Enhancer Model 875

DEFINITELY NOT A PRODUCT OF THE PAST . . . Automatically maintains picture sharpness . . . comb filter . . . coring . . . threshold control on front panel permits adjustment of amount of pre-enhancement required to inhibit local signal enhancement . . . may be used as Automatic or Standard.

## Auto-Controller Model 1100

PROFITS! . . . An adjunct to Dynasciences Editor-Programmer . . . minimize and simplify the repetitive operations involved in tape-to-tape editing . . . save time . . . reduce operator errors . . . permits tape editor to focus attention on the critical selection and refinement of the edit point locations . . . augments centralized remote control of recorder and playback VTR's, automatic rewind to pre-roll position on both machines, remote control of tone pulse recording, and automatic preview of edit points.

IF . . . you would like to know more about how our "Profit Prophet" can help you, write:

**DYNASCIENCES  
CORPORATION**

## VIDEO PRODUCTS

TOWNSHIP LINE ROAD • BLUE BELL, PA. 19422  
Telephone: (215) 643-0250 • Telex: 84-6358

Circle 127 on Reader Service Card

unit system consisting of the VIR Generator, Model 2100, and the VIR Corrector, Model 2200. The generator sends the VIR signal down the line. At the receiving end, the VIR corrector will automatically adjust, back to the values at the generator end of the line, the following: burst/chroma phase; burst amplitude; overall gain; chroma gain; set-up to 7.5 IEEE (with option). The corrector also takes care of other in-line distortions that may arise in distribution amplifiers, STLs, etc.

Automaticity is preserved with a "fail-safe" circuit that turns the unit into a simple unity-gain amplifier when no VIR signal is coming in. Operation is based, of course, on the proposed EIA standards for the VIR signal.



Tektronix/VIR video corrector, above, and CBS unit below.

What appears to be a similar system was announced in pre-NAB releases by Tektronix, who call their unit the Model 1440 Automatic Video Corrector. The maker says the system will use the VIR signal for automatic correction of video gain, chrominance/luminance gain ratio, setup level, burst phase relative to chroma, burst gain and sync gain. The unit can be remotely set to "manual" operation, with all corrections remotely controlled. If no VIR signal comes down the line, the 1440 switches automatically to manual operation. If the power fails, or a remote by-pass switch is actuated, the video signal is sent around the unit.

These two systems look like important additional stimulants to the trend toward higher standards of color quality in broadcasting.

## Moseley Introduces New Digital Remote Control

Moseley Associates has a new digital control system for remote operation of broadcast transmitters, the DCS-2,

## Simplified Automatic Cart Play from IVC

Among the really new ways of doing things to be unveiled at NAB is International Video Corporation's BCR-200 broadcast "cart" machine, which embodies an attractively simplified approach to the automation of video programming. Basic difference between the BCR-200 and most other cart machines now available is that the BCR-200 does not move the carts: each of the six helical-scan carts with one-inch tape (or 12 carts, in an extra-bay option) has its own playing position. The cart at any position can be removed and another inserted at any time. Threading is automatic; if a cart fails to thread in a few seconds it is ejected and can be reinserted. Each cart holds from ten seconds to *one hour* of material, so the system can handle not only commercials, IDs, spot announcements, etc., but also a station's full programming.

Carts on the machine can be started and stopped in any sequence automatically, under control of a computer built into the system, with full pre-programming of 12 positions available. Each bay of six carts includes one position that is for recording as well as playback; this can be used to prepare new carts while others are being played under computer control. The carts can also use tape recorded on the IVC 900-series VTRs.

The recording positions include facilities for putting cue tones on the second audio channel. After video material from any source has been re-

corded, the operator can rewind and preview the tape, stopping it at any point that a cue tone is needed. Pushing the Record and Cue Tone buttons causes the tape to reverse for five seconds while recording a five-second roll cue on the second audio track. End cues are put on the same way. A cue can be separately erased and re-recorded if a correction is needed.

A playback deck can be programmed to play a segment, rewind the cart, and eject; or play, rewind, and recue (for material to be inserted into programming repeatedly during the day); or to play, roll forward, and cue. The last mode allows syndicated programming, for example, to be stopped at any point automatically, with automatic cueing in of commercials on another cart during the pause, followed by restart of the syndicated program at the next cue.

Electronics is quite similar to that of the IVC-900 series VTRs. A built-in time-base corrector limits error to approximately  $\pm 4$  nanoseconds; drop-out compensator and processing amplifier are also built in. To reduce the chance of downtime, any deck that is malfunctioning can be skipped in the sequence; a spare can be put in quickly. Manual programming, with thumb-wheel switches, is available as a backup for the automatic programmer. IVC says the BCR-200 will sell for roughly half the cost of "Carousel" type cart machines.

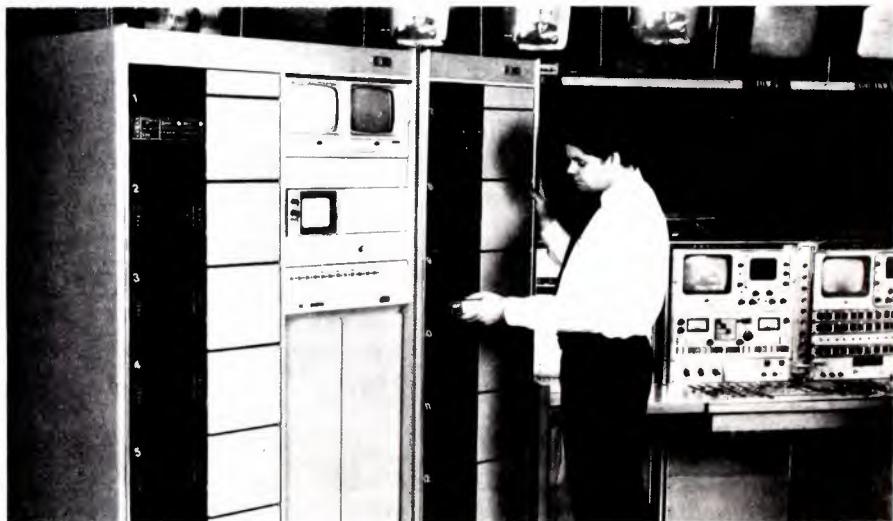

IVC cartridge videotape recorder in 12-deck, three-bay configuration offers simplified programming and extreme versatility.

which provides control, telemetry, status, and automatic logging, for all basic functions needed with a remote transmitter plant. Telemetry uses a

full four-digit number with resolution to 0.01%. Desired parameters can be logged automatically, and the status

continued on page 36



# OURS

When our RF circuit brought condenser microphones out of the recording studio and into the world, even we had no idea of the many applications you'd put them to. But what our technology made possible, your ingenuity extended in many different directions. What was once a fragile luxury, you made a necessity in location filming, audience participation shows, press conferences,



rock concerts, opera, cinema verite . . . the list grows daily in recording, broadcasting, filmmaking, education and technology. We have not rested on achievements either. Creating and improving condenser microphones with new features, new capabilities. And happily, you adopted them to an extent that has made us the industry standard. Perhaps though, you are unaware just how large the "first family" of professional condenser microphones and accessories has become. For the latest information, please write or call us.

 **SENNHEISER**

ELECTRONIC CORPORATION  
10 West 37th Street, New York 10018 (212) 239-0190

Manufacturing Plant: Bissendorf, Hannover, West Germany

Circle 128 on Reader Service Card

MARCH, 1973—BM/E

35

## Digital Techniques Bring Fresh Flexibility to Local Station Production

system gives observation of events as they occur. With a computer option, full automatic operation of a transmitter is available (when FCC rules allow). Other new items: RPL-3 and RPL-4 remote pickup transmitters, which operate in the 148-174 MHz and 450-470 MHz bands respectively, and include audio mixing facilities; and the PCL-101 aural studio-transmitter link for AM broadcasters in countries requiring operation at 150 MHz or 240 MHz.

A new series of digital electronic equipments aimed at bringing increased flexibility to local TV station productions are being unveiled by Sarkes Tarzian's Broadcast Equipment Division. Key unit in the series is the "Cinematte II," a digital special effects generator with an unusually varied complement of operation modes. As the keyboard photo shows, buttons can be punched for automatic production of a large series of mattes, wipes,

etc. The unit also can be expanded in production capability to become comparable to a motion picture editing system, and can be controlled by a computer for automatic programming.

Another unit to be shown in the digital production-tool series is a new multi-system switcher, which combines a number of digital electronic components. Sarkes Tarzian has sold one of the switcher systems to station KOOL-TV in Phoenix, Arizona. Another product to be shown is a one-line machine control system called Digiplex. A technical talk on this system will be given at the NAB engineering conference. Also at the show will be an advanced model of the "Star-Com" data communications system which Sarkes Tarzian has had under development for several years.

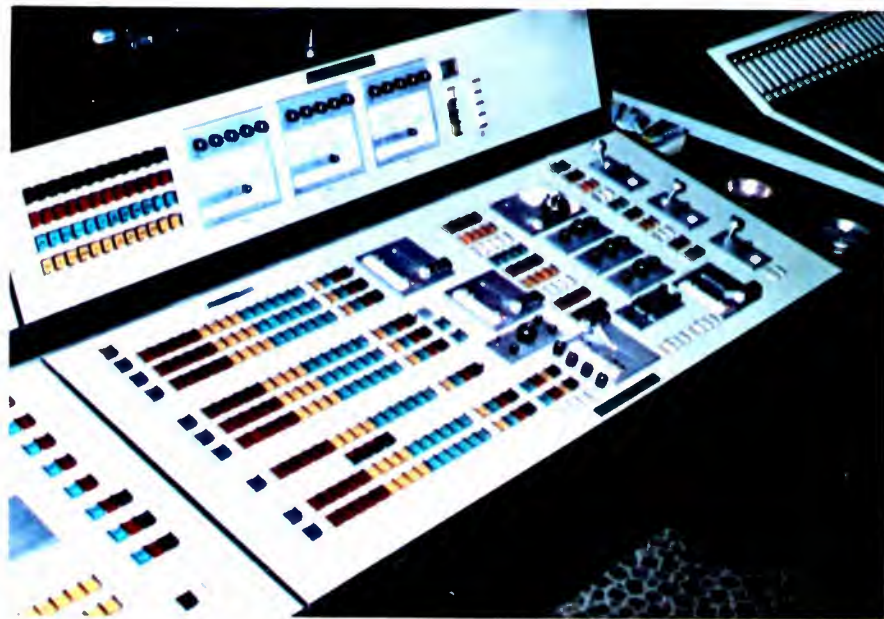

Multi-system switcher from Sarkes Tarzian (sold to KOOL-TV) incorporates digital effects generator.

## Marconi Will Show New Integrated Telecine

Marconi Electronics will introduce a new integrated telecine unit, the B3404, which includes a large complement of operating and control features aimed at efficiency in a TV station, and takes up only about 6½ by 2¾ feet of floor space. The two specially-designed 16mm projectors are mounted on open vertical plates, with a straight-line horizontal segment of film going through the drive and optical gate on a lower plate in front of the operator, and with drop-in threading. Projectors can run in forward or reverse from zero to twice normal speed (which is 24 or 25 frames/second). It has instant start (after cueing up), auto stop, and cueing to individual frames with metal markers on the film.

Light intensity is several times that needed for average film, and is adjusted by a servo-controlled 100:1 neutral density disc allowing projection of film with a very wide density range. A closed loop of film about 11.5 feet long can be run for any repeating message. Film loops are automatically maintained. Optical and magnetic sound heads are included. A 35mm projector with most of the same features is available.

An unusual optical system, avoiding the moving mirror system, controls the selection of light source: four small motors, each driving an aluminum vane that can interrupt one light path. Normally only one path is open, but two or more can be opened to superimpose images. In or out time is less than 10 ms. The two slide projectors accept 16mm and 35mm slides in

continued on page 38

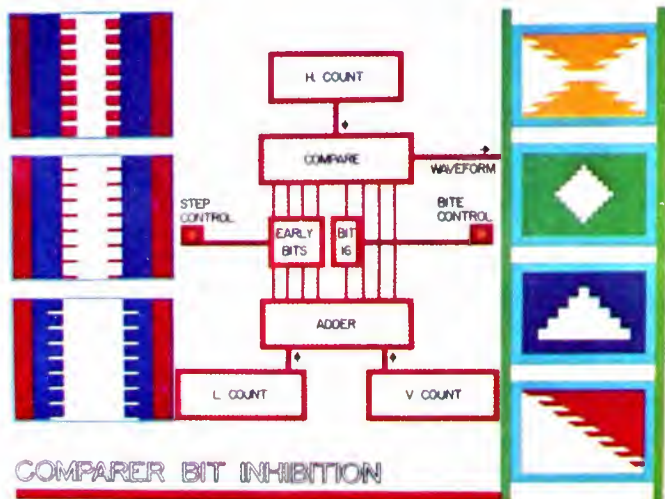

Diagram of a portion of Sarkes Tarzian digital effects generator shows some of the effects.



# Don't dub 'em, dupe 'em, or dump 'em

Use 'em! Shibaden's dramatically new color cartridge video recorder lets you use all your existing 1/2" EIAJ color or black and white tapes. No need to dupe, or lose resolution by dubbing up to 3/4" or 1" formats.

With Shibaden's SV-530 you get fast, convenient record and playback operation. Unexcelled color stability and reproduction. Exceptional reliability.

Pop-in a cartridge. Then, instant-response, solenoid-activated keyboard controls let you move to any function — Play, Record, Fast Forward, Rewind or Positive Stop. When the tape ends, it re-winds . . . automatically, and the cartridge ejects . . . automatically.

The superbly crafted SV-530 has a decorator wood case, weighs only 46 lbs. and measures less than 20" across. A true portable.

Compatibility with all EIAJ Type-1 VTRs, and considerably less tape storage space and cost than cassettes, are a few of the many other Shibaden pluses to consider.

Consider a demo. Or simply send for our Color Cartridge Video Recorder brochure. From Shibaden . . . "The Image Makers."



## **SHIBADEN CORPORATION OF AMERICA**

Exec. Off.: 58-25 Brooklyn-Queens Exp'y,  
Woodside, N.Y. 11377; 21015-21023 S. Figueroa St.,  
Carson, Calif. 90745; 1725 No. 33rd Ave.,  
Melrose Park, Ill. 60160; 100 Martin Ross Ave.,  
Downsview, Ontario, Canada.

Circle 129 on Reader Service Card



c. ortenblad III



standard 30-slide trays. Slide sequencing is automatic.

The camera is designed for three 30mm lead oxide tubes. Camera electronics include video processing: gamma correction, aperture correction (with glass delay lines for vertical aperture correction); in-band and out-of-band boost; automatic registration.

The control panel is horizontally mounted in center front, and includes pushbuttons for all automatic, start-stop and select features. A quadrant fader serves for white control, with vertical motion to adjust the light filter and rotation to adjust the black level. If color balance in a film changes and chrominance gain needs adjustment, white balance is adjusted with two potentiometers that can be set simultaneously, maintaining overall balance.

In the sound channel, there is a "Hold Sound" button which keeps the sound from a source coming through to the operator after a shift to another source for the picture.

## New Color Monitor Has Correction Matrix To Match Home Receiver

A problem in adjustment of color broadcasts has long existed because many professional studio monitors maintain the original NTSC coding and matrixing, which was based on chromaticity of phosphors then in use. Display phosphors in monitors and in home receivers today have different chromaticity; they were introduced in the interest of improved brightness, producibility, and have stability. Home receivers normally include a correction matrix which brings the color fully to NTSC standards. Thus, if the broadcaster adjusts the video signal for desirable color quality on the monitor, it is likely to be different and inferior on the home screen.

Tektronix is introducing at the show a 17-inch color monitor with Trinitron picture tube, the Model 670, which includes a switchable matrix giving essentially the same "view" of the signal as a modern, compensated home receiver. The matrix can be switched out with a front panel control to allow test and setup with strict NTSC demodulation characteristic, using color-bar signals. The monitor needs just four controls for full color adjustment: chroma gain, phase, contrast, and brightness, all fully calibrated.



New integrated telecine from Marconi is compact and efficient.

## "Exhibitors" At NAB

### Addressograph Multigraph Corp. (Booth 530).

A copy system for fast copies of logs, schedules, spots, scripts, etc.

### Acrodyne Industries (Booth 607).

TV translators for UHF and VHF; a new TV modulator; video amplifiers and peripheral equipment.

### Allied Tower Company (Booth 609).

Various tower models for broadcasting antennas; complete tower service.

### Amco Engineering Co. (Booth 558).

Special styling to match decor in modular instrument consoles, cabinets and enclosure; low-silhouette consoles.

### Alford Manufacturing Company (Booth 618).

Antennas for FM, TV, ITFS; duplexers; coaxial switches; RF measuring equipment.

### American Data Corporation (Booth 610).

Line of video test and production units includes the ADC video sync generator; a video distribution unit; the Model 570 video production

switcher; and the Model 1430 time temperature-ID character generator which has built-in clock for the time source, an integral temperature sensor which can be mounted remotely from unit (as outside a window) for automatic temperature announcements, and a keyboard for entering program or ID announcements.

### American Electronics Inc. (Booth 556).

Will show the Model RBT-500, a remote pickup microphone amplifier and control unit built into the standard Model 500 telephone set, with matching carrying case, for originating radio remotes to be fed in via telco lines.

### American Electronics Laboratory (Booth 215).

On display will be the new 50-KW AM transmitter, a 50 kW unit, and also the new 50 kW FM transmitter, a dual 25/25 with diplexer.

### American Telephone and Telegraph Co. (Booth 527).

### Ampex Corp. (Booth 200).

Several new products will be revealed at the show. Also on exhibition will be the full line of two-inch and one-inch video and audio tape record and play equipment; also the line of magnetic tapes.

continued on page 42

Circle 130 on Reader Service Card →

MARCH, 1973—BM/E



# only from Cētec



# electrodyne

## The Finest Custom Consoles

Large or small systems... no matter how complex... whatever you require in audio control for broadcast or recording, Cētec's Electrodyne can provide the answer in a console of excellent design and finest quality.

"Our purchase of your console was the best selection we could have made," said Bob Paasch, chief engineer of WCKT, the Sunbeam Television Network Station in Miami, Florida. "We talked to several of your competitors and decided—hands down—on Electrodyne. And now what really counts with us is that we're completely satisfied with the performance of our Electrodyne console."

The respected name... the leader in its field... that's Electrodyne. Designed, built and sold by Cētec, Inc.

**Cētec** INC.  
a subsidiary of Computer Equipment Corp

**Main Office**  
13035 Satcoy Street  
North Hollywood, California 91605  
Phone (213) 875-1900  
TWX 9104992669

**European Office:**  
Cētec U.K.  
Shaftesbury Street  
High Wycombe, Bucks, England  
Phone High Wycombe 37326  
Telex 778200

**Introducing  
the TK-45 camera.**

**It sees things the  
way the TK-44 does.  
But automatically.**



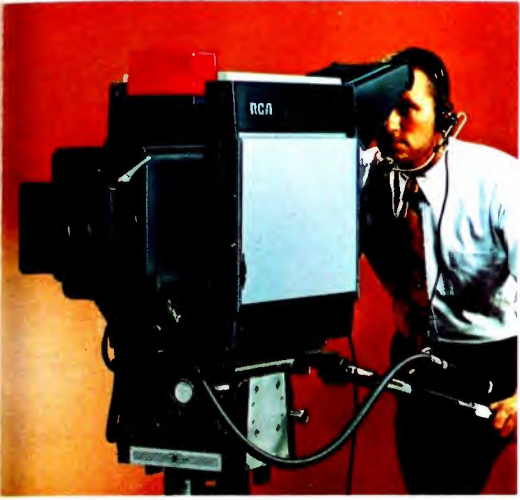

Until now, the TV color camera that couldn't be beat was the RCA TK-44.

You could depend on it for true, sharp pictures time after time.

Now there's the new TK-45. It combines what you liked so

much about the TK-44 with big new advantages.

Advantages like automatic black and white levels. Automatic iris. Automatic centering.

So you get consistent picture quality, consistent scene-to-scene colorimetry with less need for technical manipulation. Camera set-up and operation are simpler and easier.

And since the new features are located in the control unit, cable clutter is kept down.

There's more. Much more. But it adds up to this. No other camera can do more to make your productions look better—automatically.

Just ask your RCA representative. Or write for full details. RCA Broadcast Systems, Bldg. 2-5, Camden, N.J. 08102.

**RCA**

The New TK-45. It sees things your way. Automatically.

## Andrew Corporation (Booth 214).

Exhibiting the line of **rigid coaxial transmission lines**, coaxial switches, semi-flexible transmission lines, microwave waveguide, antennas for studio-transmitter links.

## Angenieux Corporation of America (Booth 109).

An operating model train set will provide visual subject matter for in-the-booth demonstrations of the 15:1 **zoom lens**, Model E61 f/2, which will be mounted on an operating video camera feeding a monitor unit.

## Asaca Corporation of America (Booth 522A).

Introducing a **portable color video camera** that one man can carry and operate; also a line of CCTV cameras and associated equipment.

## Audio Devices, Inc. (Booth 520).

Will feature the new A2 **audio tape cartridge** and the **stereo-phased A2 cartridge**, along with the complete line of magnetic recording tapes and magnetic film; also the duplicator-quality cassette.

## Ball Brothers Research Corp. (Booth 314).

Full line of color and monochrome monitors in a range of sizes.

## Belar Electronics (Booth 544).

A complete line of type-approved AM, TV, FM, FM-stereo, SCA, frequency and **modulation monitors**. Demonstration will include live off-air monitoring, using the companion RF amplifiers of monitor units. RF amplifiers are separate units to reduce problems of using built-in RF amplifier near transmitter site. Demonstration of AM monitor will show accuracy in reading 125% positive peaks, and the separate indication for negative peaks.

## Berkey-Colortran (Booth 303).

A new **soft-light design** is the "Mini Soft-Lite," designed for two 500, 750, or 1000 watt lamps.

## Beston Electronics (Booth 700-701).

Will introduce new **automatic light control systems** for color film chains; also the Model 650 special effects generator with "Wondra-Wipe;" and a unit for adding vector display operation to standard oscilloscopes. Also: a line of distribution amplifiers for audio, video, and pulse signals.

## Bird Electronic Corporation (Booth 539).

Instruments and components for **RF power measurement**, including high-power load resistors, RF directional wattmeters, RF power and VSWR monitors; 2 kW. to 50 kW coaxial loads and attenuators; coax loads and attenuators; coax switches; RF power sensors; and many others.

## Robert Bosch Corporation (Booth 526).

Featured will be the KCU-40, **large studio color camera** with self-registering and self-balancing in operation; KCP-40, smaller color video camera; KCR-40, hand-held color camera with same automatic circuitry as KCU-40; KCF-40, color film chain; FFCC-40 automatic color corrector for enhancing signal from worn color film; and the TCP, TV-140, and KP-40, CCTV color cameras.

## Boston Insulated Wire and Cable Co. (Booth 322).

Wire and **cable products** for broadcasting and CATV.

## Broadcast Computer Services (Booth 533).

**Computer services** for traffic and accounting in broadcasting and CATV.

## Broadcast Electronics (Booth 107).

Will show their line of **audio tape cartridge systems**, including a new compact playback unit, the Model 370, only 5½-inches wide; three fit across a normal 19-inch rack space. Also: the Titlemaster character generator with audio interface; the 1070 Mini-series. The booth will include a complete studio set up to show the use of the equipment on display.

## Broadcast Facsimile Network,

Inc. (Booth 554).

## Broadcast Products (Booth 514).

Introducing a **60-tray random-access cartridge assembly** for automated systems, the Multicart 600 series designed for standard Type A audio cartridges; also a new line of audio consoles designed specifically for automated systems, with eight inputs (three out (left, right, mono); also the new Station Master Traffic and Accounting System, with integral computer for control of all station logging, traffic, and bookkeeping. A distributor for the Dolby noise reduction system, will demonstrate at the booth the use of both Dolby A and Dolby B in broadcasting applications. Line of automation systems including the AR-2000 and AF 1000, on display.

## CBS Laboratories (Booth 103).

See the highlights section for description of new CBS **VIR Correction system** for automatic color signal correction at end of long transmission line, using the vertical interval signal. Also shown will be the CBS line of video processor, character generators, and related equipment.

## CCA Electronics Corp. (Booth 224).

New line of **TV transmitters for UHF and VHF**, plus antennas for same (first showing of former Ampex line with CCA improvements); also a new solid-state remote pickup and STL system; new audio consoles; new cartridge record-playback units; a new FM antenna.

## Canon USA, Inc. (Booth 507)

**Lenses and optical equipment** for TV cameras and 16mm motion picture cameras.

## Cellomatic Productions Corp. (Booth 501A).

**Cueing, prompting and rear-screen projecting equipment** for television including a new improved prompting system not previously exhibited in this country.

## Central Dynamics Corporation (Booth 207).

Will introduce the new VS-120

continued on page 44

Circle 136 on Reader Service Card

MARCH, 1973—BM/



# Colormatch.



Find out what it means to you.  
See the Conrac demonstration at NAB.  
(Sheraton Park Hotel, Booth No. 222)



## CONRAC

The true measure  
of color in broadcasting.

Conrac Division  
600 North Rimsdale Avenue  
Covina, California 91722  
213 966-3511

series of **video production switchers**, featuring soft-edge wipes as well as other special effects. Also to be unveiled at the show will be a new **videotape editing system**, the TV-200, which uses SMPTE code, with built-in generator, for a moderate-cost editing installation. Other products on show: remote transmitter control units; the PEC-102 computer-controlled videotape editing system; the VK-2140 encoded chroma keyer.

## **Century-Strand, Inc. (Booth 601).**

Studio **lights and lighting controls**, accessories.

## **Cohu Inc. (Booth 519).**

The new Model 1500 **color video camera**; the new 9501 video production switcher; the 1230 viewfinder studio color camera; the line of video processing equipment.

## **Colorado Video, Inc. (Booth 550).**

Model 260 **Video Compressor** will be shown which allows conversion of TV signal to narrow bandwidth for transmission over voice grade circuits. This is a new model which is more efficient than earlier units. Model 261 **Video Expander** will be shown which reconverts compressed signal to standard 525 line picture. Company will discuss system that sends a still picture over FM subcarrier in seven seconds.

## **Commercial Electronics Inc. (Booth 524).**

Will show **new enhancer and sync generator** for CEI 280 camera system. Other accessories for CCU will be displayed. Live camera demonstrations will be featured.

## **Communications Carriers, Inc. (Booth 603).**

Introduced will be a straight-thru **RF repeater** for intercity microwave systems; a **portable microwave system** for intra-city use; low-noise preamps for microwave systems. Units operate on 6 and 12 GHz.

## **Compu/Net, Inc. (Booth 542).**

Availabilities/billing automation.

## **Conrac Corp. (Booth 222).**

Will introduce the **new Series 5000 19-inch and 25-inch color utility monitors**, with shadow-mask tubes. Will also show in final form the Series 1000 solid-state TV demodulator. A number of the latest version of the RH Series of broadcast monitors will be set on the same program material to show extremely close color matching achieved with the color-controlled phosphors used.

## **Continental Electronics Mfg. Co. (Booth 320).**

High-power **AM broadcast transmitters**.

## **Data Communications Corporation (Booth 557).**

Computerized **on-line management system** for broadcast accounting, traffic, sales.

## **Datatek Corp. (Booth 563).**

Will introduce the new D400 compact, low-cost, **video/audio switcher**, controllable in a wide variety of ways: also an envelope delay measuring set, a TV transmitter color equalizer and waveform corrector. Also a full line of distribution amplifiers for video, audio, and pulse signals.

## **Datatron, Inc. (Booth 548).**

The new **videotape editing system** brought out by Datatron, the Vidicue 5050, can control simultaneously any two quad or helical VTRs that have electronic edit capability. Priced at \$10,000, the system includes an SMPTE time-code generator, with the system set up so it is no longer necessary to pre-record the code for editing. During pre-roll, the internal generator is automatically synchronized to the code recorded during the previous scene, and begins recording at the edit point. This reduces headwear from repeated runs through, and provides an immediate elapsed program time. Optional additions include one for precise frame-to-frame sync of the two VTRs, and one virtually eliminating overshoot.

## **Datavision, Inc. (Booth 521).**

Will show the complete line of **video character generators**, including the D2400, D1500, and the new D1032.

## **Delta Electronics, Inc. (Booth 532).**

**Transmission line measuring equipment** for on-the-air monitoring, in-

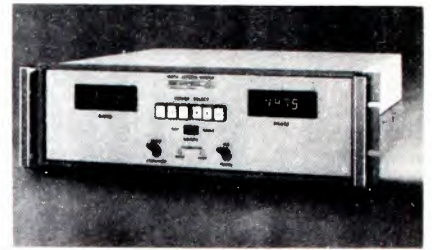

cluding impedance bridges, common-point bridges, receiver/generator.

## **Dynair Electronics Inc. (Booth 317).**

Will show their line of **distribution switching equipment**. Included are logic units for remote control of video and audio switching, interfacing with dial, thumbwheel, computer, or other control systems. New: a modular patch cable unit for audio/video routing, which can be expanded as need arises; the SE-70A special effects generator for color video (SE-70A-R in a remote-control version).

## **Eastman Kodak Company (Booth 528).**

Will have the Kodak Video Film Express parked in front of the hotel for **on-the-spot filming and fast processing** of motion picture film. Also shown will be the new Kodak Supermatic 70, **cassette film system** with integral magnetic recording and playback.

## **Echo Science Corp. (Booth 612).**

See highlights section for description of new **portable one-inch VTR** introduced.

## **EMCEE (Booth 316).**

UHF and VHF TV translators, 1 watt to 1 kilowatt; TV antennas; ITFS systems.

## **Electro Sound, Incorporated (Booth 604).**

Will introduce a new series of **professional audio open-reel recorder/players**. Will also show their in-cassette duplicator, and their full line of broadcast audio units, including mixers, preamplifiers, power amplifiers.

## **Fairchild/Robins (Booth 309).**

A whole new line of standard  
continued on page 46



it's on record...



Now it's official! An association equipment survey quoted in *BM/E* magazine produced some very revealing information on FM broadcast industry preferences — particularly in the category of phono cartridge usage, where a whopping 57% of the respondents expressed their preference for Shure cartridges . . . *more than all other brands combined*. It didn't particularly surprise us because we know our M44 series with its uncommon combination of clear sound, low cost, exceptional ruggedness and excellent back-cuing characteristics, has been the broadcast standard for years. And our peerless V-15 Type II Improved? There simply isn't a better cartridge for "high fidelity" FM operations. Write for the free Shure "Guide to the Conversion of Monophonic Broadcast Facilities for Stereo Records," as well as the complete Shure Phono Cartridge Catalog.

Shure Brothers Inc.  
222 Hartrey Ave., Evanston, Ill. 60204



Circle 141 on Reader Service Card

broadcast **audio consoles** are being shown, offering many engineering advances and covering a broad price range, intended to meet requirements of many classes of user.

## Fidelipac Division of Telepro, Inc. (Booth 511).

**Automatic tape cartridges**, the series 300, 600, and 1200; also cartridge racks and other accessories.

## Imero Fiorentino Associates (Booth 509).

**Studio lights** and lighting design.

## Fort Worth Tower Co., Inc. (Booth 308).

**Antenna towers**, all sizes, for broadcasting and CATV systems.

## Gates Division, Harris-Intertype (Booth 211).

Shown for the first time will be the Stereo 80 **audio console** with 18 inputs, switchable to eight mixing channels, with distortion less than 0.5% at all frequencies; the CB-1200 professional turntable, with three speeds, flutter and rumble well below NAB requirements; and a full line of **video color cameras** (formerly the GE video camera line), which includes the TE-201 video color camera, an economical unit with plug-in view finder and compact package; the top-of-the-line PE-400 color camera, which includes an automatic circuit for preserving detail in high-contrast areas; and the PE-245 color film camera, a four-vidicon unit. Gates will also show **transmitter systems**, control consoles, and other items.

## Gotham Audio Corporation (Booth 305).



As additions to the extensive line of **recording and broadcast items** from Neumann, EMT, Studer, etc., Gotham will introduce: the Studer

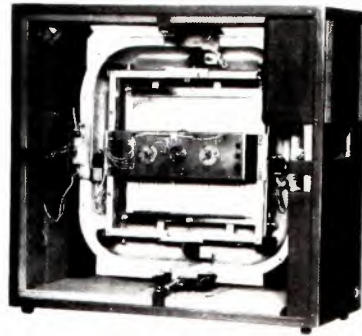

A80 and B62 tape recorders; the EMT 928 turntable, for professional broadcast use; and the Neumann KU80 artificial head for binaural recording.

## Grass Valley Group, Inc. (Booth 300).

Introduced at the show: the new 1600 series of audio/video **production switching systems**, with integral mixing systems, standard effects, pattern edge selection between soft ("video vignette") hard, and matted, and with improved keying techniques. Also new at the NAB is the **Border Line Generator**, which provides character generation with outlines selectable as to hard, outline alone, or drop-shadow effect. Other products: the 1400-12 low-cost production switcher for mobile or small video installations; the 1400-24 automation units for switchers, with the APC-2000 computer.

## GTE Sylvania (Booth 304).

**Tungsten halogen lamps** for TV studio lighting.

## Houston Photo Products, Inc. (Booth 613).

No information.

## IBM Corp. (Booth 615).

## Ingersoll Products (Booth 551).

**Cabinets and modular enclosure systems**, with sloping front, low profile; contemporary styled enclosures.

## Innovative Television Equipment (Booth 563).

**Video camera mounting equipment:** dollies, stands, heads, etc., for all sizes of camera.

## International Good Music, Inc. (Booth 223).

A new complete operating unit, shown at NAB for the first time, is the Model 740 **automated audio control system**, which includes an integral mini-computer, two 48-unit stereo Instacart players, two reel-to-reel transports, automatic time-temperature announcer, keyboard control desk, and high-speed, English-print-out, automatic logging unit. Also introduced will be the new BAT 1000 **computerized system for control of traffic, billing, payroll, etc.**; a simplified, two-rack Model 400 control system, demonstrating "Sounds For All Seasons" taped programming; and the Model 502-4 system with Instacart and direct-access MOS memory. The IGM tape program services will be available for auditioning in a separate Sheraton Park suite.

## International Tapetronics Corporation (Booth 538).

Introduced at the show will be a new line of broadcast-oriented **reel-to-reel audio tape machines**, which have three-motor design. There are



models for 10½-inch and 14-inch reels, single or dual speed; all have motion sensing, edit mode, and IC logic. Also on display will be the complete line of single and multiple-deck cartridge systems.

## International Video Corp. (Booth 220).

**Video cameras; video helical recorders;** see also description of new BCR-200 automatic video cart system in highlights section.

continued on page 50



# Think big. Start small.

Just about everyone knows about the CMX System/600. It's the most advanced, sophisticated video tape editing system in the world. And we're proud of it.

What everyone doesn't know is the fact that we make a lot of other computerized video tape editing systems and components. And we're just as proud of them. The CMX System/300 for instance, a complete on-line video tape editing system. It allows you to edit and assemble frame accurate video tape masters. With a maximum of creative control. And a minimum of fuss and bother. And since it's a component system, you can start small and build big. A piece at a time.

Then, there's our newest system: The System/400. It's a system that allows you to edit on helical tape. Off-line. Then assemble

the final master on 2 inch hi-band. Automatically. You can buy it alone, or add it on to an existing System/300.

But, although our systems fit your needs, a complete computerized system may not fit your pocketbook. That's swell with us. We also build a lot of useful editing components. Beginning with an audio insert editor that sells for \$1,050. Which means you can keep right on thinking big; but, you can start small. And build from there.

We create the post-production systems components and computer programs that make complete creative control of video tape possible. It's a good business for us. It may be an even better business for you. And we'll be at the NAB Show to tell you why. Drop by. We'll be in booth 502. With our systems.

**Start here.**

Mr. G. G. Heitel  
Marketing Manager, CMX Systems  
635 Vaqueros Avenue  
Sunnyvale, CA. 94086

Dear Jerry,  
I'm interested. Please send me descriptions and information on CMX editing systems and components. We're thinking.

Name \_\_\_\_\_

Title \_\_\_\_\_

Firm \_\_\_\_\_

Address \_\_\_\_\_

City \_\_\_\_\_ State \_\_\_\_\_ Zip \_\_\_\_\_

You can expect to see me at the NAB Show, too.

cmx systems

Circle 132 on Reader Service Card



# Measure exact frequency in the field

With lab quality digital accuracy



- Model 155A Automatic Counter
- 5Hz to 32MHz frequency range
- Auto-ranging, including automatic decimal point positioning
- 5 digit display with Hz, KHz and MHz indicators
- Only 3½ lbs. and 2"H x 4½"W x 8½"D
- \$475

- Model 155B 100MHz Counter
- 5Hz to 220MHz frequency range
- Resolution to 10Hz at 220MHz and 1Hz up to 20MHz
- 7 digit display
- Only 3½ lbs. and 2"H x 4½"W x 8½"D
- \$795

Monitor frequency with a Monsanto digital counter faster and more accurately than by analog methods. Crystal controlled clocks and all solid state components insure reliable, long-term stability. These instruments are operable from the AC line, 12V to 32VDC mobile sources and optional battery pack. The Model 155A battery pack allows for completely portable operation at only \$200. For a demonstration contact your local Monsanto representative.

## Monsanto

Precision measurements to count on.

United Systems Corp.

918 Woodley Road • Dayton, Ohio 45403 • (513) 254-6251 • a subsidiary of Monsanto  
All Monsanto instruments are available for rental or lease through Rental Electronics, Inc.





**Broadcast Automation.  
Schafer Electronics Invented It.  
Schafer Electronics Developed It.  
Schafer Electronics Keeps Improving It.**

## **Schafer Electronics IS Broadcast Automation**

Join us at NAB booth 225 and help us celebrate our twentieth year of service to the radio broadcast industry. And if you have a few minutes we'd be delighted to demonstrate one of our newest systems for you. If you won't be at NAB, write and we'll send you information.

# **schafer**

### **Schafer Electronics Corporation**

75 Castilian Drive, Santa Barbara Research Park  
Goleta, California 93017

Schafer Electronics Ltd.  
5824 Burbank Road, SE, Calgary,  
Alberta, Canada T2H1Z3

In Hawaii, Mexico, Puerto Rico  
and the Virgin Islands contact:  
Schafer International  
1355 Harbor Drive  
San Diego, California 92101

For the rest of the world contact:  
EMI Sound & Vision Equipment Limited  
252 Blythe Road, Hayes  
Middlesex UB3 1HW England

## Jamieson Film Co. (Booth 535).

Color film processing equipment.

## Jampro Antenna (Booth 310).

FM duplexers, towers and accessories, high-power FM and TV antennas, transmission lines, tower lighting equipment.

## Jerrold Electronics Corp. (Booth 503).

A wide variety of CATV headend and line electronics units; engineering of complete systems.

## Johnson Electronics, Inc. (Booth 217).

New, redesigned models in line of FM/SCA tuners and receivers; also a new portable SCA/multiplex demonstration unit.

## Kaman Sciences Corp. (Booth 533).

Fully automatic computerized traffic and accounting services for television and radio; on-location computer will be demonstrated. (Equipment and services formerly sold by Broadcast Computer Services, Inc.).

## Kliegl Brothers (Booth 226).

Will introduce the 5 kW Small-Pak, a Fresnel luminaire designed for compact studio requirements. It is 15 inches front to back, has a new quartz Mogul bipost lamp holder, brass focus mechanism with front and back handles; tilt knobs; clear or black riser lens. Kliegl will also give a working-studio lighting demonstration, showing how a well-lit studio is set up with fill, key, and back lights, cyclights, and various forms of effect lighting. Can be viewed "live" as well as through a video camera chain.

## LPB, Incorporated (Booth 540).

A dual-output mono audio console, the S-15, has eight input channels giving capability for up to 19 input lines; each channel has step attenuators, leaf-type telephone switches, with all active components on plug-in modules. Second output, with characteristics identical to first, can

be used for monitoring or for production and recording while first is on the air.

## Landy Associates (Booth 555).

Featured are to be the new modularized monochrome video monitors made by Modtec Corporation; and the McBee Industries' automatic loggers for radio and television.

## Lenco Electronics (Booth 704).

Will introduce a family of video, pulse, and subcarrier distribution amplifiers. The PVA video distribution amplifier has a loop-through input and four isolated outputs. Plug-in accessory will add differential input and equalization. The PPA pulse distribution amplifier has simi-



lar input-output arrangement, pulse amplitude fixed at 4 volts, and width equal to input width at the 50% point, for inputs from 1.0 to 5.00 VPP. Sub-carrier unit, Model PSA, has one input, two dual outputs, goniometer for phase adjustment. All units go into 3½-inch rack frame, with matching power supply.

## Listec Television Equipment Corp. (Booth 529).

Introducing the new Vinten Mark V lightweight camera head, with complete hand-control facilities. Also showing the Vinten heavy-duty Mark IIIA camera head, available with external drag controls; Vinten tripod and pedestal dolly units; the Fulmar Type 702 pneumatic pedestal, with very low operating height.

## McBee Laboratories (Booth 555).

A new item is the V11/21 automatic digital logging system, which records and prints out meter readings. The completely self-contained system prints and displays the date, time, channel number, and meter readings in volts, amperes, watts, etc. Integral with the unit is a solid-

state, 24-hour digital clock to supply exact time for display and print-out.

## McCurdy Radio Industries, Inc. (Booth 307).

Will show their line of audio units for broadcasting, including three desk-mounting mixing consoles, the SS4388A, an eight-input unit for news booth or disc jockey area; the SS7400, a 12-input monophonic dual channel console; and the SS7500, ten-input stereo console. Other items are the SS3157 monophonic and SS3158 stereo console disc reproducers, the SS7300 intercom and a line of variable equalizers, preamplifiers, distribution and power amplifiers.

## McMartin Industries, Inc. (Booth 213).

New items on exhibit include the TBM-8800 AM RF amplifier to convert AM modulation and frequency monitors to off-the-air operation, which has separate broadband outputs for modulation and frequen-



cy feeds, manual or automatic gain control, carrier loss alarm circuitry and local/remote switch. Also introduced at the show will be the TBM-2000B monitor for FM-SCA transmissions, which measures modulation, frequency deviation, injection level, S/N ratio, and with built-in measurement of internal noise. Other new items are the TR-E2 receiver for FM/SCA transmissions; and the dual-channel version of the 500 series audio consoles, designated B-503.

## 3M Company, Magnetic Products Div. (Booth 104).

Introducing the new Series 400 videotape line, on cushion-flange reels and also in RCA and Ampex cartridges; also shown will be 3M U-Matic cassettes with a variety of 3M tapes, as well as the complete videotape line for quad and helical machines and the line of audio tapes. Another intro: the new Series 330 magnetic film, on acetate base with improved low-noise oxide.

continued on page 52





## Need a low cost, high quality, station "in house" monitoring system?

A television station "in house" monitoring system designed around the EiE CTM1 Color Television Modulator and the CTD1 Color Television Demodulator can be an effective, low cost and relatively simple method of meeting your station's monitoring requirements.

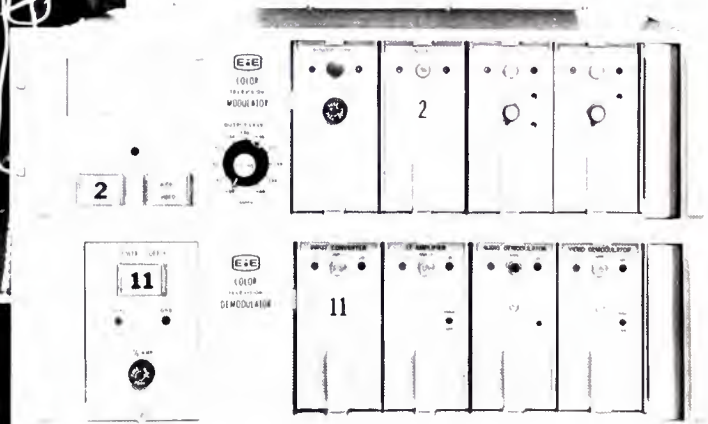

An EiE RF Distribution System eliminates the disadvantages associated with video/audio distribution systems such as prohibitive cost, system complexity and restricted monitoring capability. With the CTM1 Color Television Modulator which can be equipped to meet the FCC group delay predistortion requirements, station staff personnel can receive faithful reproduction of their product on consumer quality color TV receivers. Once the system is installed, anyone in the station who needs private monitoring can be accommodated for little more than the cost of the receiving/display equipment.

Write or phone today for more information on how your station can install an RF Distribution System for "in house" monitoring.



**Electronic  
Industrial  
Engineering**  
A Division of RCA

7355 FULTON AVENUE · NORTH HOLLYWOOD  
CALIFORNIA 91605 · PHONE (213) 764-2411

Circle 135 on Reader Service Card



## 3M Company, Mincom Div. (Booth 105).

Introducing the new M79 series of **2- and 4-track audio recorders** designed especially for broadcasters, using 1/4-inch tape; shown also will be the M79 16-track recorder with synchronizer; video/sound synchronization will be demonstrated.

## Marconi Electronics Inc. (Booth 108).

See highlights section for description of new Marconi **B3404 telecine**.

## Marconi Instruments (Booth 108).

The new Model 2914 **TV Automatic Monitoring System** for TV transmitters, with digital readout, using VITS for analysis; with the 2915 unit added, will correct out-of-limits operation. Also new: Model 2910 non-linear distortion analyzer, which simultaneously reads differential gain, differential phase, luminance, non-linearity; also the Model 2913 VITS generator.

## Marti Electronics, Inc. (Booth 106).

Highlight will be solid state **remote pick up transmitter/receiver** RPT 40 and R 30/150. This system was previewed last year, but it is now in full production and ready for delivery. Also to be shown is the 950 MHz aural **SLT remote control and telemetering system**. Other products: audio amplifier including the CLA-40A compressor limiter; the PGM 20 program/line amplifier; the MA 10 monitor amplifier, and a complete line of accessories.

## Memorex, Video Products (Booth 502).

CMX computer-assisted **videotape editing system**: full line of quad and helical scan videotapes.

## Micro-Communications, Inc. (Booth 616).

**RF switching combiners**, filters, duplexers, switches, loads; TV and FM antennas.

## Micro-Trak Corp. (Booth 515).

The line of broadcast tone arms,

including viscous-damped models; broadcast turntables; the Series L line of studio furniture, including consoles, cabinets, tape cartridge racks, etc.; the Model 2570 automatic antenna control system; models 6400 and 6401 phono preamps; the Series T line of monitor speakers. Also: introducing a new master clock for broadcast applications.

## Microwave Associates (Booth 504).

**STL microwave systems**, including a 1/2-watt 12-GHz link; also 1 watt intercity and STL system on 7 GHz; low-cost local loop systems; portable B-line microwave links; high-power H-line repeaters for intercity network relay applications.

## Miratel Division, Ball Brothers Research Corp. (Booth 314)

Introduced will be an updated version of the **Video Production Center**, which includes switching and special effects for video program control. Interlocked, fail-safe switching prevents loss of program by operator error. The unit accepts synchronous or non-synchronous, composite or non-composite, color or monochrome signals.

## Mole-Richardson Co. (Booth 315).

**Quartz studio lights**, low-power and high-power; stands, many accessories.

## Moseley Associates (Booth 313).

See the highlights section for description of **new digital system for**



**remote control** of broadcast transmitters.

## Nagra Magnetic Recorders, Inc. (Booth 702).

The SN Mini-recorder; the Nagra line of **portable audio recorder/players**.

## North American Philips, AKG Division (Booth 203).

Will unveil at the show the new CK-8 **short-shot-gun condenser microphone** for the C-451 system; and the

C412, which has a four-position selector giving omni, figure-8, cardioid and super-cardioid patterns.

## Nortronics Company, Inc. (Booth 212).

**Magnetic recording heads and accessories**; cleaning and maintenance equipment for video and audio recorders.

## Paillard, Inc. (Booth 606).

**Bolex 16mm cameras**, automatic for single and double sound filming; Super 8 cameras and projectors; other pro cameras and accessories.

## Paulmar, Inc. (Booth 617).

Will exhibit **film inspection and editing equipment**.

## Pentagon Industries, Inc. (Booth 549).

**Professional duplicators** for cassette and open-reel tape recordings.

## Phelps-Dodge Communication Co. (Booth 553).

**Coaxial cable and accessories**; remote pickup antennas; other broadcast products.

## Philips Broadcast Equipment Corp. (Booth 202).

Will feature the **studio video camera line**, among them the Norelco PC-72, with CLUE (camera line-up equipment) for quick set-up; the digital PC-100A; and the moderate cost 3-Plumbicon model, LDH-1-B. Also: a number of portable cameras, including the PCP-90B, and two "surprise" portables to be unveiled at the show. Each day a prize will be awarded consisting of a Pro 12 audio tape recorder to the engineer whose name is drawn from among those doing a set-up on the PC-72 in the booth. Other items: a low-cost telecine microphones; mixing consoles. Also: the Norelco VTR color videocassette recorders. All equipment will be "hands-on" for visitors.

## Potomac Instruments, Inc. (Booth 608).

Showing the full line of **antennas, monitors** and field strength meters.

## Power-Optics, Inc. (Booth 221).

Remote control systems for professional television.

continued on page 54



# FLICKINGER

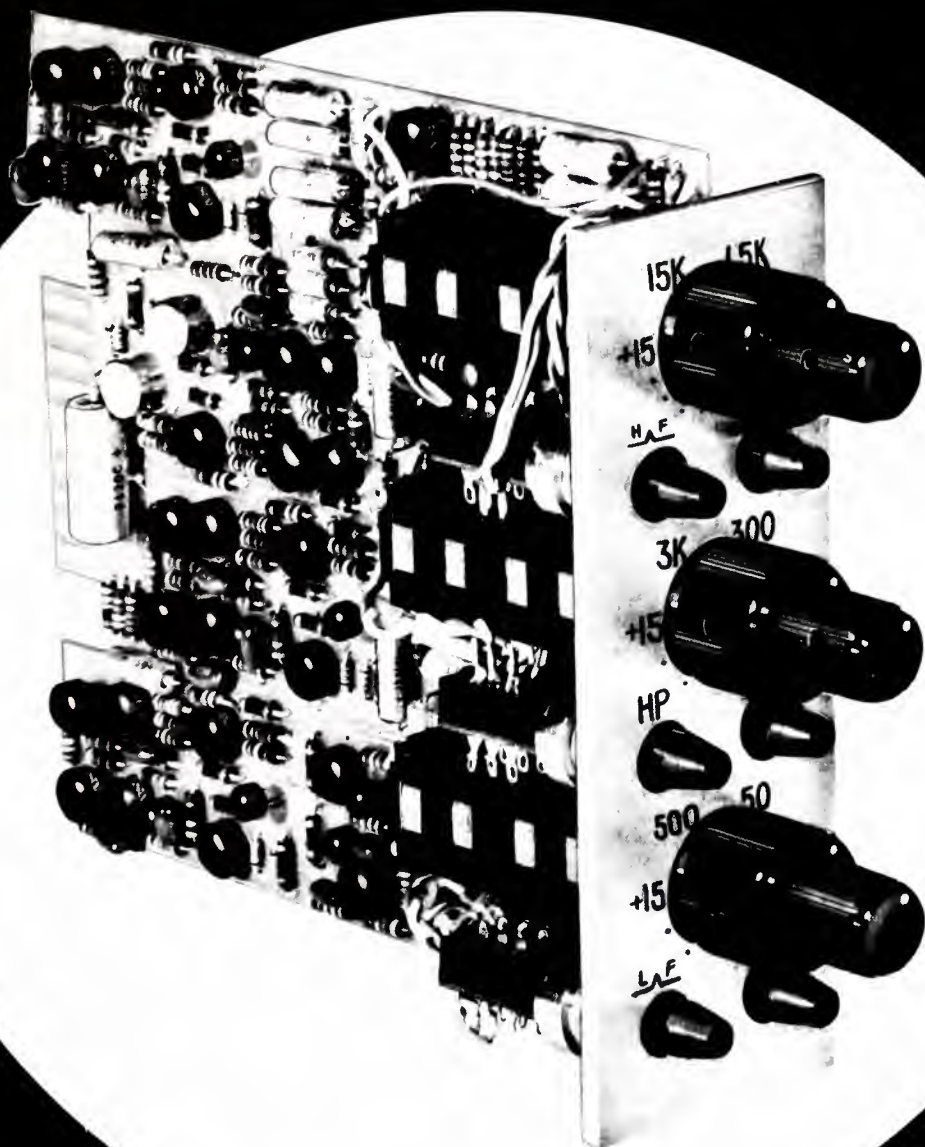

## MODEL 167 EQUALIZER

- 3 Overlapping Ranges
- Infinitely Variable Frequencies
- High Pass Filter Network
- Separate Peaking and Shelving Controls
- Independent Range Operation
- No Insertion Losses

For more information  
phone 216/656-2000  
or write Daniel Flickinger Inc.  
Hudson, Ohio 44236

## Profit Recovery Systems (Booth 559A).

Line of **equipment for recovery, recycling, and pollution control** of waste chemicals from film processing units, including: the TV Pac, a complete recycling recovery-pollution-control system which extracts silver from waste with an electrolytic process, and regenerates cyanide bleach solutions and treats other waste materials with ozone generated within the system; and the Silv Pac, which includes the silver-recovery operation only.

## Q-TV Sales and Distributing Corp. (Booth 302).

"Q" **prompter systems**; prompter accessories; crawl systems.

## Quick-Set, Inc. (Booth 506).

**Camera pedestals**, dollies, tilting heads, cam-link heads, accessories.

## RCA Communication Systems Division (Booths 100-101).

Will emphasize the **automation capabilities of RCA broadcast equipment**. A miniature theatre will be set up to demonstrate live action of TCR-100, automatic cart machine. Also on demonstration: automatic features of TK-44 video camera. Introduced will be new television film products and new transmitting products.

## RCA Electronic Components (Booth 102).

**Vacuum tubes**, klystrons, vistacons, vidicons, test equipment.

## Raymar Associates (Booth 608B).

## Recortec, Inc. (Booth 536).

Two new items shown will be the **Video Tape Evaluator** and **Video Tape Conditioner**. The evaluator is a stand-alone tape deck that tests videotape longitudinally to report total length, number of surface defects, edge damage, and splices. An optional printing accessory records the locations of all defects. Tapes are also cleaned, degaussed, and precision wound after testing. Total test time is eight minutes for a one-hour reel. The Conditioner is a stripped-down version that cleans and winds only.

## Research Technology, Inc. (Booth 559).

The **Retectron Model A500 machine**, allowing operator to clean, inspect, edit and time 16mm film in one operation; film storage systems.

## Revox Corporation (Booth 560).

Will show the new M201 **Beyer microphone**, a super-cardioid dynamic designed especially for radio and TV broadcasting with extremely small size for its type; will also show the Revox tape recorder with Dolby B circuitry, the full line of Beyer microphones. A small operating studio will be set up, using Beyer microphones, Revox recorders, and the Lamb compact control units.

## Reynolds Leteron Co. (Booth 547).

**Graphics for TV titles**; special system for producing letters and other graphics as needed.

## Richmond Hill Laboratories (Booth 319).

Will introduce the new VPM-41 **portable production video switcher**, with all electronics on control panel—has ten inputs, four busses, special effects, faders; also a 20-input video switch with white key; and a new video routing switcher.

## Rohde and Schwarz (Booth 312).

New products to be shown include: A new **Tracking Unit**, for use with the Videoscope 3 sweep analyzer, which makes possible frequency response measurements on TV transmission lines with long signal delay (such as transcontinental and satellite circuits), and on tape recorders; also the new **TV field-strength meter** for the 25-300 MHz band; a new TV translator, the Model HS2061, for VHF and UHF; and a new TV demodulator with front-end receiver, usable in remote control systems. In addition, many other units in the extensive line of test and monitoring devices will be on hand.

## Rohn Communications Facilities Co., Inc. (Booth 321).

**Towers** for FM, AM, TV, and CATV antennas.

## Rust Corp. (Booth 210).

**Automatic digital remote-control systems** for transmitters; automatic logging systems, including low-cost logger for operation through remote-control circuits; status and alarm systems.

## Sarkes Tarzian, Inc. (Booth 209).

See highlights section for description of new **digital video production switchers** and special effects generators introduced.

## SC Electronics, Inc. (Booth 559).

Will introduce new 12-inch **monochrome video monitor**, and also new single and triple six-inch monitors.

## Schafer Electronics (Booth 225).

New items will be: Model 900 series of **solid-state automation systems**, including the 902 MOS memory system accommodating up to 19 broadcast audio sources, with built-in time insertion capability and digital clock; and the 903 MOS memory system addressed through a keyboard or punched paper tape, accommodating up to 19 audio sources, addressable sequentially or by real-time insertion. Also: systems for verified and coded **automatic logging** in full English print-out, connectable to all Schafer systems. In addition, the Schafer 8000 computer.

## Scully-Metrotech (Booth 614).

On the show list are the Scully 280B series **recorder-reproducers**, the Metrotech 400 series loggers; the Metrotech time-code generator-reader, complementary to the 400 series loggers; and the Metrotech 500 series recorder-reproducers.

## Shibaden Corporation of America (Booth 318).

Equipment for CCTV systems, including a full line of **color cameras** and associated equipment.

## Shively Laboratories, Inc. (Booth 546).

FM and TV **antennas, transmission lines, dummy loads**, coaxial switches, multiplexers, antenna towers, and many related items.

continued on page 56



# Get the professional look from helical-scan Ampex **VPR-7950**

## It's that good!

A super-sharp teleproducer can see the superior quality of a VPR-7950 picture compared to one from any other 1" recorder.

### What is a VPR-7950?

The world's highest performance 1" color/monochrome, helical-scan videotape recorder. It incorporates the same advanced design features of the Ampex VPR-7900 and the TBC-790 time base corrector in a handsome, highly functional console.

Video waveform and picture monitor selector switches may be used together or independently. An eye-level panel includes both monitors as standard equipment and an optional vector display scope.

The VPR-7950 is a complete recorder/reproducer which features:

- Very high carrier mode (7-10 MHz) for exceptional quality in color dubs even down to 3rd and 4th generations; 5th, in black and white.

- Precision, fast, *total*, electronic insert and assemble editing from any signal source.

- Internal digital reference system that includes a horizontal lock servo, frame lock and vertical interval switching.

- Three independent tracks (single video - dual audio), each of which can be used, altered, edited or replaced at any time.

- High efficiency ferrite video head with 500 hour warranty and the fastest, simplest replacement system ever devised.

- Capstan controlled high speed tape cycling modes, velocity loop tension servo, direct coupled drum servo, minutes and seconds coun-



ter, monitor amplifier and cue microphone.

In developing the time base corrector, Ampex engineers discarded current technology and took a new



*Ampex VPR-7900 recorder/reproducer  
with TBC-790*

digital approach to time base correction that affords the most stable video signal ever produced by a helical-scan recorder. It produces clean fades, lap dissolves and special effects as well as dubs of edited material of outstanding quality to 1" and 1/2" videotape recorders, quadruplex recorders and transfers to film.

Like the VPR-7950, the combination of the VPR-7900 and TBC-790 produces recording capabilities that meet all standard broadcast requirements. The TBC-790 may be purchased with the VPR-7900 you may now own. The VPR-7900/TBC combination is portable enough for use as a mobile unit for location work. Tapes made on the VPR-7900 are completely interchangeable with those made on the VPR-7950.

Round out your teleproduction system with the Ampex CC-500 color camera system, which incorporates professional features, is simple to operate and low in price.

*CC-500 Camera*

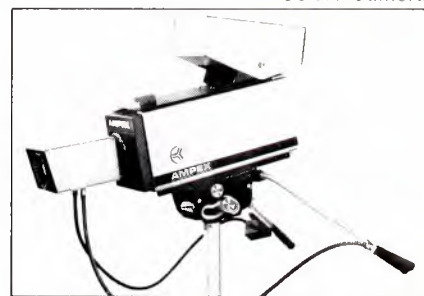

Call your Ampex Dealer or write: Audio-Video Sales, Ampex Corporation, 401 Broadway, Redwood City, CA 94603.

**AMPEX**

Circle 138 on Reader Service Card

## Shure Brothers, Inc. (Booth 306).

The full line of **professional microphones**, mixers, disc reproducers, tone arms, microphone accessories, preamplifiers, etc.

## Skirpan Lighting Control (Booth 552).

Studio **lighting control systems**, including computerized control with cathode-ray tube for data insertion and status display.

## Soll, Inc. (Booth 513).

**Engineering and consultation** on design and installation of all broadcast facilities; station planning; design, construction and installation of RF switching systems.

## Sono-Mag, Systems Marketing Corp. (Booth 227).

Will introduce a complete **new line of automation systems** for FM and AM radio broadcasters, including: the AP-1 Alpha programmer which can store more than 60,000 programmed events, handle an FM and AM station simultaneously; the DP-1 digital programmer; the Sequential programmer; and the moderate-cost Formatter. Also new will be the bi-directional, all-silent "Caroussel" automatic cart system, and the new SMC single-cart recorder/player, which handles all three standard cart sizes.

## Sparta Electronic Corporation (Booth 310).

The new Model 680 **FM exciter** aims for greatly simplified operation and maintenance with digital AFC



control circuitry, which keeps the transmitter on frequency without ovens; automatic carrier balance; and strip-line RF circuitry. Also



new at the show: a "**building block**" system for automation equipment, allowing a modest-cost beginning with expansion as needed; the Corinthian series of open-reel tape decks, for reels up to 16 inches; RS250 random-access cartridge system; Centurion II custom audio console; and a new 1 kW AM transmitter, Model 701B.

## Spindler and Sauppé (Booth 516).

Introducing the new **Spectrum 32 TV-film chain**, including dual 16mm slide magazines for color and monochrome, wrap-around preview lights, twin 500 watt, 200-hour lamps with elapsed time meter, turbine blower and air filter, remote control, modular electronics, built-in power supply; also the Ultrabright system for single-camera background projection, up to ten times as much light as beam splitter systems, dynamic dissolve adjustable from instant cut to slow lap.

## Stanton Magnetics, Inc. (Booth 545).

Will show the Series 500, Standard Broadcast line of **stereo pickups**, and the 681 Calibration Standard line, all available with a variety of styles tip sizes and compliance values; the Dynaphase 40 and Dynaphase 60 stereo headphones; and a new preamp-equalizer for feeding a magnetic stereo phono pickup into console input circuits.

## Storeel Corporation (Booth 541).

Systems for space-saving **storage of television equipment** and accessories.

## Superscope Incorporated

Marantz **preamplifiers, amplifiers, tuners**; Sony 854-4S four-channel tape recorder; Sony Condenser and Electret-Condenser microphones.

## Systems Resources Corp. (Booth 512).

Television **character generators**.

## Taber Manufacturing and Engineering (Booth 543).

New and refurbished **audio heads**, head refinishing, **tape degaussers** for tape up to two inches wide, audio test tapes.

## Tape-Athon Corp. (Booth 517).

**Tape recorder/reproducers** for broadcasting; automation systems for complete on-line control; the Model 900 very-slow-speed tape recorder for logging up to 20 days on one reel; background music library.

## Tapecaster TCM, Inc. (Booth 505).

Will feature their new Mark IV 300 series **audio cartridge**.

## Technology Incorporated, HF Photo Systems Div. (Booth 602).

The line of "Little Max" **color film processors** has been extended to cover Super 8 and 35mm film. Units hold all processing functions in compact form. Processing speed ranges from 5 to 21 feet/minute, depending on model.

## Tektronix Inc. (Booth 206).

See highlights section for description of new **Automatic Video Corrector**, Model 1440, which uses the VIR signal for automatic color correction of end of transmission line



or satellite circuit. Also in the highlights section is a description of the new Model 670 color monitor, which includes a correction matrix to match compensation in home color receivers. Will also introduce: a new gen-lock test signal generator, model 145; the new Model 1441 VIR signal deleter/insertor, which takes program off selected line and inserts VIR signal; and the improved models 147A and 149A NTSC test generators.

## Tele-Cine, Inc. (Booth 537).

Introducing a new Schneider 30:1 **zoom lens** for 1 1/4 inch and 1 inch

continued on page 122



# The uncomplicated teleprinter



A small, quiet, multi-copy machine which simply plugs into the power and signal line like a portable typewriter.

We do not use any super-sophisticated technology which takes a PhD to troubleshoot. Our machine is a solid little workhorse of extreme simplicity, it does no more or less than is required by knowledgeable users who depend on minimal downtime.

**Ask the people who use them.**



Manufactured in the U.S.A. by

**extel**

Extel Corp., 105 W. Adams St.,  
Chicago, Illinois 60603.  
(312) 372-9841

Circle 139 on Reader Service Card

# The quality that TAV produces is like the camera it uses.

Trans American Video does great work. They really have an eye for video tape. In fact, they're quite a unique video facilities company. When it started in business over a year ago, it ordered none of the first Fernseh cameras sold in the U.S. TAV used those cameras to cover the U.S. - Russia track meet and then proceeded to become the world's largest independent mobile color video tape facilities company. Their current credits include NFL Monday Night Football, Young Dr. Kildare series, Pat Buchanan in Sharon, La special, Duke Ellington - We Love You Madly special, and Frankenstein Parts I and II feature.

Today, TAV has over \$8 million worth of equipment. And here's what they have to say about Fernseh cameras.

It took only a short training period for our operators to learn to use the cameras, and for the camera to establish themselves as quality pieces of equipment.

The Fernseh cameras are easy to set up and strike. Once they're required, they're extremely stable. A video operator does not have to continually ride the picture.

There's a lot more we can tell you about the family of Fernseh cameras. Interchangeable modules. Small diameter cabling. Performance specifications, etc. For more detailed information, contact your local Fernseh division representative at one of the offices listed below.

Chicago: (312) 681-5000

Houston: (713) 841-1111

Los Angeles: (213) 649-4330

New York: (212) 900-9000

Ramsey, N.J.: (201) 829-1550

San Francisco: (415) 582-9470

## Robert Bosch Corporation Fernseh Division

Circle 140 on Reader Service Card







# Buffalo: A Modern TV Plant Aids, And Shares In, Regeneration of Downtown Area

WGR-TV's new plant, a totally modern TV facility, is also a key structure in the rebuilding of the city's center.

TAFT BROADCASTING'S WGR-TV, Channel 2, went on the air in Buffalo, New York, last December from a new TV plant satisfying splendidly not only the technical needs of the operation, but also the desire of the management to aid, and participate in, the current regeneration of the city's center. The massive renewal project envisions new structures for many governmental and business operations. For its dual purpose, Taft moved to the center of the downtown area, the only TV plant there. The company spent about \$3½-million and got a building with an exterior that adds greatly to Buffalo's "new look," and holds fully modern technical facilities.

WGR's management has its sights set on, among other things, becoming a "good citizen" with strong involvement in the community. One first move in that direction was the donation of the old TV facility, which was well out of the downtown area, to WNED-TV, Channel 17, local ETV station. WNED is already in the process of revamping the building.

WGR's new building includes a "community room" which the management hopes to make a meeting center for many local groups. It includes film, videotape, and slide equipment, and will be open as freely as possible to responsible groups that need such facilities. Availability of the room is being widely advertised in the community.

The two-story building holds all executive offices and administrative space for programming, public affairs, promotion, sales, news, and all engineering except the transmitter, which is a few miles away, tied in with a microwave link. There are 45,000 square feet of space, on a landscaped area that totals 95,000 square feet. Binghamton brick lines the first floor; a 74-foot wall of tinted windows complements the building's main entrance. Sidewalks outside are heated in winter. A reflecting pool in the plaza will hold sculpture depicting the role of television in contemporary life. The open terrace outside the lobby, with trees, flowers, grass areas, and mar-

ble benches, can double as an outdoor TV studio.

As an NBC affiliate, WGR programs many prime-time network shows, including network news programs. However, the station is going for a strong local character as well, based primarily on a twice-nightly half-hour local news program, at 6 and 11 p.m., with WGR's own anchorman, Ron Hunter, to shape up the presentation. Remote crews will cover important local events on videotape for editing into the news show; the in-studio staff will comment. The management considers the local news effort one of the most important elements of its community involvement, and also of its drive for enlarged commercial success. They are frankly shooting at the number one position in local news held (when this was written) by the ABC affiliate, WKBW, on Channel 7.

Many local shows will be produced in the two new studios, which are 40 x 60 feet, and 60 x 80 feet, respectively. WGR will also promote the use of the studios for general commercial video production.

The larger studio includes two built-in bowling alleys, allowing the presentation of a local show that is obviously going to be immensely popular. Called "Bowling for Dollars," the show goes on at 7 p.m. five nights a week and pits guest bowlers against each other in pairs, with each getting two rolls. Two strikes wins a jackpot, which may be over \$1000; high scores win lesser amounts. People who want to compete are being invited on the air to send in for "entry cards," and WGR, at last count, had taken in about 60,000 requests! Similar shows have been started in a few other cities.

The \$800,000 worth of new equipment, installed under the direction of Hal Higgins, manager of engineering, and Ed Gordon, engineering supervisor, starts off with three up-dated GE PE250 color cameras, two equipped with new Q-TV teleprompters. Commercials, IDs, spot announcements, are usually handled by an RCA TCR-100 video cart machine, but automation will generally be confined





Exterior of new WGR-TV studio-administrative building in downtown Buffalo has brick facade on first floor, tinted windows above. Glass-enclosed tower holds microwave antenna for air link to transmitter.



Engineering Supervisor Ed Gordon inspects RCA TCR-100 cart system for many commercials, IDs, spot announcements. Major part of programming is produced live from studios or from NBC network feed, with some from open-reel VTRs.



Looking over shoulder of program director Ernie Rouert at push-button panel of sub-control switcher (RCA TS-51) which receives inputs from studios, lines, VTRs etc., and routes them as required. Vidifont special-effects generator, and chroma keyer are also at position.



A main control position at WGR-TV, with large studio window facing operator, switcher under his right hand, studio monitors above window, monitors for other inputs below window, operation monitors at far left. Each studio has its own control room.

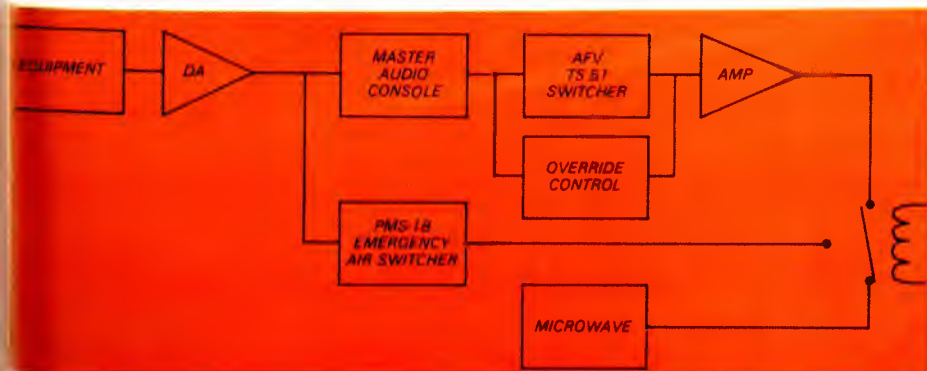

Block diagram of switching system shows automatic re-routing circuit which sends program through PMS-18 if main switcher fails.



WGR-TV puts strong emphasis on local news with reports each night at 6 p.m. and 11 p.m. Above, members of the news staff, at one end of large news room, prepare copy for the local news reports.



The WGR-TV "News Cruiser" operator checks out a local happening with a Buffalo patrolman. Film cameras or portable videotape units record newsworthy events for integration into the two nightly local reports.



Chief photographer of WGR-TV, Terry Johnson, inspects one of the film cameras he will assign to a news crew to record an event for the station's local coverage.

to that area. There are two RCA TS-51 switchers, two custom-built audio consoles, three custom-built film chains.

Master control area has an RCA TS-51 System 20 switcher with AFV, into which WGR's engineering staff inserted a custom audio console for level control of individual sources. The staff also modified the audio circuitry to allow override of 12 sources, rather than the six in the original design.

Sub-control uses an RCA TS-51 System 26 dual re-entry switcher with two TE-60 special effects units and chroma key. The custom-built console provides 62 microphone inputs, 16 mixers, four sub-channels, and two output lines. Both studios have CBS Vidifont generators and custom-built RCA remote control panels for VTRs and film chains. The

VTR and film equipment includes three TR-70s, one TR-22. The three film islands have TK-27 cameras updated with contour adjustment, four TP-66 projectors, and two TP-6s.

Terminal equipment is all RCA with sync distribution via an RCA Consync system, TA-19 processing amplifier, and TA-53 distribution amplifier. An emergency switcher system (drawing) feeds all video and audio through a PMS-18 switcher in case of failure of the master control switcher. Studio transmitter link is a Raytheon RTR-2A system with a glass-enclosed microwave tower on the new building. Transmitter includes an RCA PT-10 that drives an RCA 25-BL final amplifier.

Taft Broadcasting, and Buffalo, can be extremely proud of the new WGR. **BM/E**



AMPEREX PLUMBICON\*  
TV CAMERA PICKUP TUBE



*This is the tube  
that was in the camera  
that revolutionized TV broadcasting  
seven years ago.*

INTENSIFIED  
SILICON-VIDICON

SILICON-VIDICON



VIDICON

PLUMBICON

**This is the line,  
the only line  
that includes all four types  
of one-inch camera tubes  
currently used in  
today's TV cameras.**

Amperex, who gave the TV industry the Plumbicon camera pickup tube seven years ago, is the only manufacturer of all of the four types of one-inch pickup tubes used in today's TV cameras.

Recognizing the obligations that have accrued to us as the number one source for the component that is the heart of the TV camera, we extend an invitation to anyone who is contemplating the purchase or the design of a TV camera system to discuss his specific requirements with us, with complete confidence in the objectivity and validity of our recommendations. Whatever the application — color or black and white, telecasting or video-taping, CCTV or CATV, industrial, educational or medical, surveillance security or military reconnaissance.

Electro-Optical Devices Division,  
Amperex Electronic Corporation,  
Slatersville, Rhode Island 02876  
Telephone: 401-762-3800



**Amperex®**

TOMORROW'S THINKING IN TODAY'S PRODUCTS

Sold through  
North American Philips Dealership Component Corporation



# Eight Years of Updating End In A Final Splurge— Result Is A Completely Modern Stereo FM Plant

WWDL, on 104 MHz in Scranton, Pennsylvania, built their spanking new studio-office plant around their old one without any cross-talk in ongoing programming.

A PROGRAM FORMAT DESCRIBED BY DOUGLAS V. LANE, president of WWDL-FM, in Scranton, Pennsylvania, as "wide middle-of-the-road music" has paid off for the stereo station which covers a good part of the northeast section of the state. The station started quite small in 1964, with a studio and office building of only 800 square feet. Original studio list included only a Gates stereo yard control board, one E-V microphone, two Gates Cartri-Tape II cartridge units. WWDL was 100% in stereo from its first day on

the air, the first stereo station in Scranton.

Each year thereafter WWDL added to its programming facilities. And last year the station got a building to house it all properly, with room for any future expansion needed. Designed by Mr. Lane, in collaboration with an architect, the new studio-office plant has 4000 square feet of space with just about everything a "music" FM stereo station needs for effective operation.

With construction going on around the active studio, WWDL kept construction noise out of the programming by shifting announcers and DJs back and forth to put distance between them and the work crews. Additional "on-air" red signals were put up so that carpenters could avoid hammering or sawing when on top of live mike positions. These precautions succeeded so well that no listener called in to ask what a power saw or active hammer was doing in the music.

The studio line-up now gives high efficiency for WWDL's program format, with most music played from discs, but some current hits on tape cartridges and some older material on open-reel tape. Gates Stereo Yard console and Stereo Statesman console feed an Audimax 111 AGC amplifier, which feeds telco lines to the transmitter (about two miles away). Gates Criterion stereo record/playback units are in each of the two studios, along with four ITC compact stereo playback units, selected because of low mechanical noise when starting and stopping.

ORK turntables were chosen for flexibility in shifting between 45 and 33-1/3 rpm. Micro-Trak tone arms have Stanton 681-SE cartridges, which have proven to be rugged and easy to cue back. The six open-reel machines include Ampex and Teac models.

"The announcing staff does not crowd the micro-



WWDL's old building, with 800 square feet of floor space, before the expansion program that incorporated it into the new building, shown in lower photo on opposite page, extends across one end of the old, with a new entrance at far right.



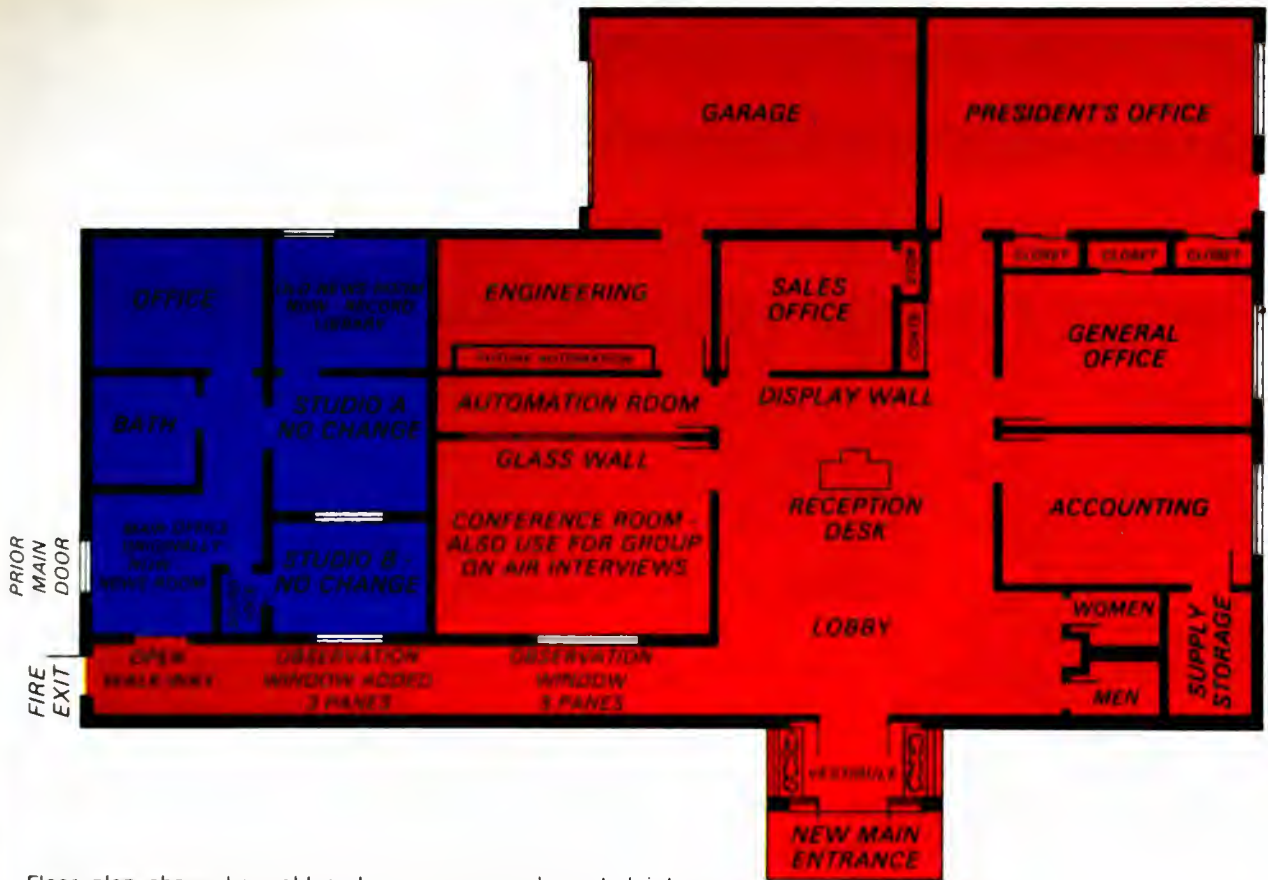

Floor plan shows how old and new were amalgamated into a greatly enlarged stereo FM plant which has everything needed for a successful "wide MOR" music operation on stereo FM.





Close-up shot at disc jockey-announcer position in one studio shows how program origination equipment is all within reach: Gates cart machines, Ampex open-reel tape player, QRK turntables with Stanton 681EE phono pickups, RCA microphones.



Looking over control desk with Gates console, the second studio can be seen through window, with a variety of origination and control units.

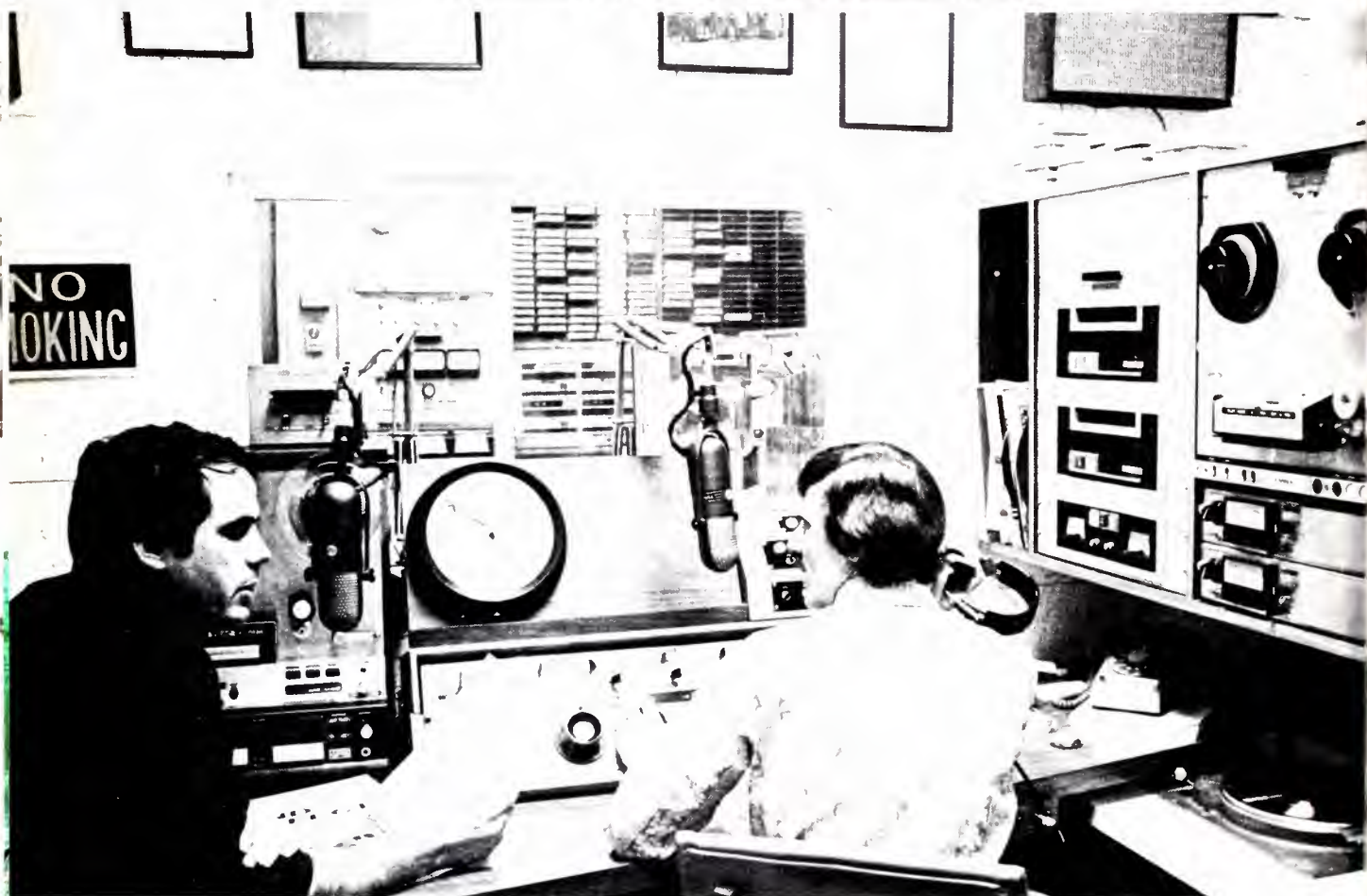

phones, and a soft-sell approach is used," says Mr. Lane, "and we have found RCA 770X microphones effective for this approach." McMartin monitors and RF amplifiers are in the main on-the-air studio, to work with a Gates remote control system. UPI audio feeds are handled automatically by the tone-activated control amplifier. Martin book-shelf speakers are used as monitors throughout. An automatic hourly time tone unit was home-brewed from two Singer timers.

With the studio arrangements (see photos) an announcer or DJ can do just about everything in the programming line without leaving his control chair.

Also in the building are all the offices, the record library, a conference room which is control-board equipped for recording interviews, and a room intended to hold automation and computer equipment in the future, as well as the present engineering office and maintenance area. The building is heated by electricity and has zoned air conditioning.



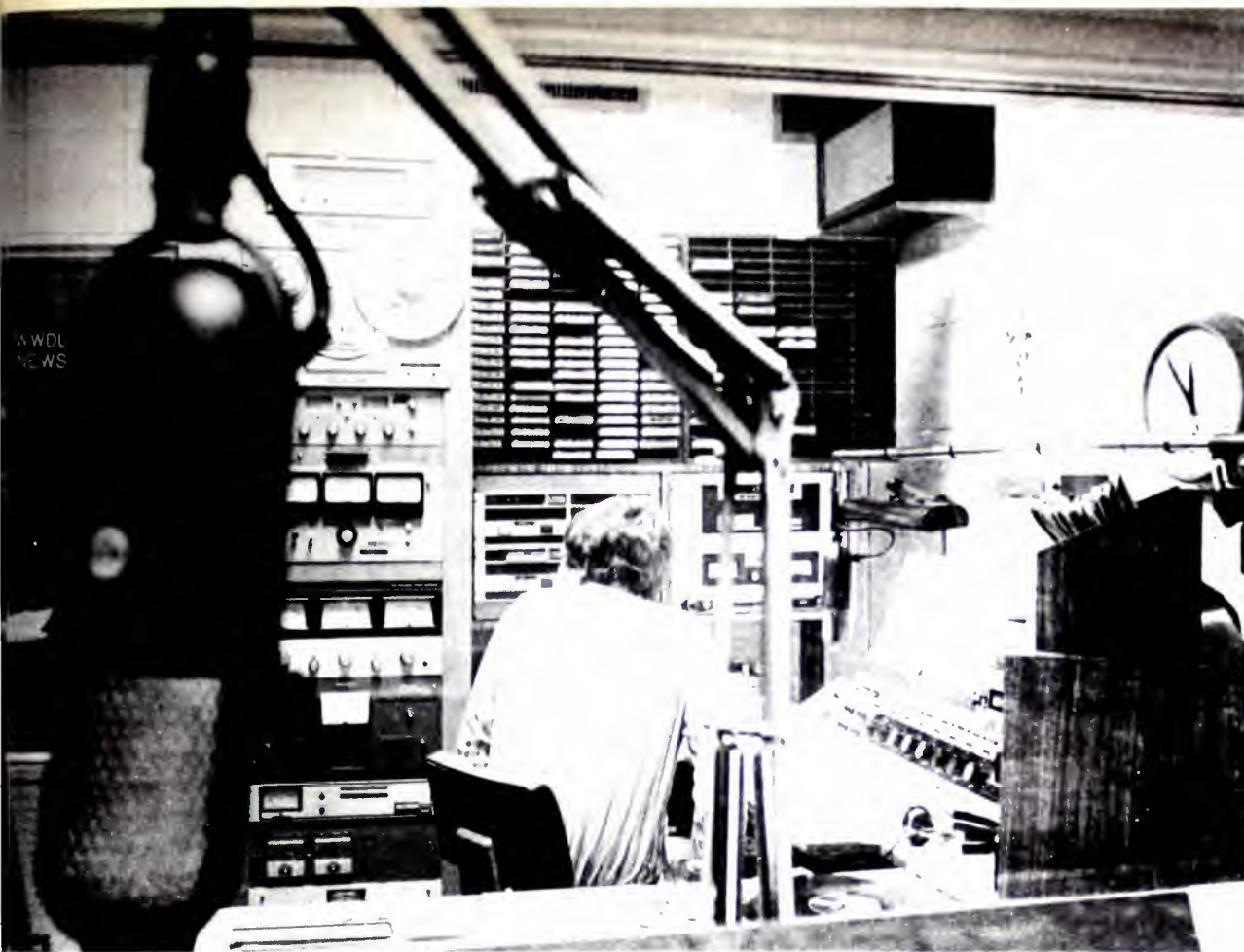

WDL  
NEWS

Closer shot of second studio shows Gates console, on control desk at right, open-reel and cart tape machines on rear wall. Door to news room is at left rear.



At left is the original equipment set-up at the main control position, shown in its present state in the pictures on the preceding page. New studio is behind wall at announcer's rear, as indicated on floor plan and in facing-page photos. Evident in earlier photo, above, are the cartridge and open-reel tape machines, console, single microphone.

The transmitter plant, on top of West Mountain, includes a 350-foot tower with single-bay circularly polarized antenna, and an auxiliary antenna on the building. Gates FM-IH3 is the main transmitter, and Gates ISC the auxiliary, which is kept in stand-by at all times and can be put on the air from the studio in about one second.

Emergency transmitter power comes from a Kohler 15 kW unit with propane-fueled generator. A modified stereo Volumax at the transmitter gives

adequate peak control. There is also a small emergency studio in the transmitter building.

Concludes Doug Lane: "A well-equipped facility is a vital necessity if an FM station is to serve itself and the community well. We have been highly gratified by our recent showing, with ARB surveys putting us frequently number one in the Scranton/Wilkes Barre area, in a number of the demographic quarter-hour shares. Our plant efficiency is an essential part of this showing." **BM/E**

# Traffic Speeds Up And Station Personnel Slow Down As Computer Tie-ins Solve Long Time Problems

DURING THE HEIGHT of the political campaign last fall, a salesman rushed into the Traffic Department at station KOB-TV, Albuquerque, and breathlessly gave Dorothy Smith, traffic manager for the station, a last minute schedule of spots that "just had to go right away."

Miss Smith, with a nonchalance bordering on indifference, took the schedule to a small machine in the corner of her office, punched keys for a few minutes, then sat back and waited. Within three minutes the machine began to clack back: when it was through Miss Smith tore off the read-out from the machine, looked at the salesman, and nodded "okay."

If there was any doubt that times had changed in the Traffic Department of KOB-TV it was quickly dispelled by Miss Smith, who returned to the little machine, typed out the changes for the daily program log in a matter of seconds, and returned to her desk.

"Two years ago," said Miss Smith, "that salesman wouldn't have dared come into the office with that kind of a request. He'd have found a bunch of screaming maniacs wearing out pencils in an effort to keep the log up to date."

Miss Smith looked fondly at the console sitting in the corner of the office and said, "It doesn't look like much does it? But it's absolutely breathtaking. After 25 years of manual operating and one year's exposure to the computerized handling of traffic, I just don't know how we ever managed before."

To people familiar with the organized chaos of the average station Traffic Department, the scene at KOB-TV, even during the ritual of "making up the log"—which often resembled New Year's Eve in Times Square—is now serene and efficient.

The revolution in streamlining and modernizing traffic departments has long been overdue and there

are several systems now available for overworked station traffic people which could change not just their efficiency, but their on-the-job attitudes, according to Miss Smith.

"The traffic job used to be sheer drudgery," she said, "and the constant updating, changing and substituting to keep the log up to date probably caused more personality traumas in TV than anything else. The pressures that were always hanging over the girls in traffic are no longer around and all traffic work can now be done, thanks to our central computer system, with a minimum of pressure and a maximum of effectiveness."

KOB-TV uses the BIAS computer system (Broadcast Industry Automation System) which is operated out of Memphis, Tennessee, and although there are several other systems on the market (see *BM/E*, September 1972, KOB-TV seems quite happy with its current system.

Miss Smith pointed out a number of specific areas in which the computerized traffic had streamlined the work for her department. "We used to have to type the daily logs three days ahead," she said, "which meant three days of continuing and exasperating changes. Now, with the help of the computer console tied-in to Memphis, we run our final log at 2:30 p.m. the day before it's current. And, where we used to slave for hours over the log, we can now put out the final copy in just 30 minutes."

Changes in the log, which have long been the bane of traffic people, now can be done in seconds, according to Miss Smith, and service orders can be confirmed within 30 seconds.

Jerry Danziger, vice president and general manager of KOB-TV, calls the BIAS system a "super-tool." "This system has so much potential," says Danziger, "that I don't think we fully understand its scope. What it has done for us to date, however, has been





Dorothy Smith (left), KOB traffic manager, shows computer print-out to general manager Jerry Danziger

fantastic. "Instant avails" has always been a major goal for any station—that we have, but it is only a small part of the information this system makes available for us. It has enabled us to get our "accounts receivable" faster and decrease the payment lags from agencies. It provides us with a complete breakdown on our sports—by classification, product, product protection—all in minutes. It does our billing and keeps it up to date, gives us a running account of costs, and running account of daily revenue."

Danziger attributes much of the station's increase in revenue to the capacity the computer system has to analyze and project spot information quickly. "During the recent political campaign," said Danziger, "the competition was turning down business because according to their logs they were out of saleable time. We had a similar circumstance in a prior campaign and reached the same conclusion only to find, too late, that there were plenty of spots still available. With the computer system we say, 'what have we got?' and within minutes we know. Thus we were able to handle a greater number of political advertisements than ever before."

But, to Jerry Danziger, the most important advantage of the BIAS computer system for his station is the complete informational check of all phases of the KOB-TV operation that the system can provide.

"This system is capable of producing every form of report a station manager could want," says Danziger. "Station gross on a running hourly basis—comparison of sales of individual salesmen—you can get it by the hour, day, or week; expenses on specific sales related problems—breakdowns are available in minutes; rotation of spots within certain time periods—zap, at your finger tips."

"Not only does the system streamline your operation," says Danziger, "but it stops you from making

mistakes. If you try to log competing products together the console says 'that's a no-no.' If you're overloaded in any time period with spots, the system tells you so. If duplication occurs, the system wants to know why."

"The BIAS system," says Danziger "institutes its own dialogue if it's not satisfied with the informational input. And that scares me."

Danziger pointed out also that in addition to the atmospheric changes that had occurred in his Traffic Department, it had also caused some important personnel changes. "Where we used to have four or five girls in traffic always typing changes in the log or up-dating the records, now we have two girls handling the whole affair and, with the increasing knowledge on their part on how to handle the computer system, their jobs have become far less tedious. We have been able to utilize the other girls in different areas of the station."

Danziger indicates that the interfacing of the equipment in the early stages caused a few traumatic experiences, but, since the bugs have been worked out, the system operates like a charm. "I think it's one of the greatest developments for station administration in years," said Danziger, "and with the ever-increasing load of paperwork, the continually growing complexity of spot-buying, logging, billing and confirming, I don't know how a station can continue to operate without some form of computerization."

The Hubbard Broadcasting Company, which owns and operates KOB-TV, has been installing one of the most sophisticated computerized systems available at its home station at KSTP-TV, Minneapolis-St. Paul, utilizing the BIAS system. The standard BIAS service is used at Hubbard's WTOG-TV, an independent UHF station in Tampa-St. Petersburg, Florida.

**BM/E**

# We admit... we have created a generation gap!



1954  
D-24

1971  
D-124

1954  
D-19

1971  
D-190

When it comes to cardioid dynamic microphone developments **AKG** is purposely creating a generation gap.

We have to, because we insist on staying far ahead.

Imitation is the sincerest form of flattery and while others attempted to equal the acoustical properties and duplicate the design appearance of the D-19 and D-24, **AKG** continued in setting the pace by developing a new family of transducers with superior performance characteristics.

The D-19 and D-24 are the finest microphones in their

class, as thousands of owners will attest. However, new techniques and materials made fundamental design changes possible. Gone is the complicated "plumbing" within the microphone requiring slots or holes along the microphone body, and these essentials are improved: smoothness of response, uniformity of directional characteristics, front-to-back ratio at all frequencies and ruggedness.

The **AKG** D-124 and D-190 are the newest generation of cardioid dynamic microphones, designed for today's requirements.

For detailed information,  
see your authorized  
local **AKG** dealer  
or write to us.



## MICROPHONES • HEADPHONES

DISTRIBUTED BY  
NORTH AMERICAN PHILIPS CORPORATION  
100 EAST 42ND STREET, NEW YORK, NEW YORK 10017

Circle 142 on Reader Service Card





Bill Wertz, VP of WQLR, checks the chronometer, as Dennis Weidler is poised to put the station on the air, Pat Dyskiewicz and Eric Toll watch.

## Stanton. Brings on the new.

A new Station, and a new sound hits the air in Kalamazoo, Michigan. WQLR STEREO starts serving the market in June, 1972 with all new equipment and new programming. Every cartridge on every tonearm at WQLR is a Stanton. Vice President, Bill Wertz states, "We chose Stanton because we were starting fresh and we needed to impress the community with the quality of our sound from the very first on-the-air minute. Naturally, the well-documented reliability of Stanton's 500 series cartridges helped influence our choice."



Artie Altro makes the WOR-FM sound, while Eric Small, Sebastian Stone and Promotion Director, Kim Olian look over a new album.

### Radio stations all over the nation specify Stanton.

For on-the-air use, Stanton 500 series cartridges have the ability to withstand rugged handling without any lessening of audio quality. They meet all standards for reliability and sound quality, both in on-air playback usage, and in the production of transfers. These characteristics, which assure high quality sound with minimum maintenance, make them ideally suited not only for professional use, but for home stereo systems as well.



Scott Muni, WNEW-FM, cues in on a new release.



Engineer Brian Morgan of WDRC AM/FM, gets ready for on-air playback.

You can enjoy the professional audio quality of Stanton Products whether your purpose involves broadcasting or home entertainment.

Write today for further information to Stanton Magnetics Inc., Terminal Drive, Plainview, New York 11803.



All Stanton cartridges are designed for use with all two and four-channel matrix derived compatible systems.

Circle 143 on Reader Service Card

# The Competition Sounded Louder Than We Did— How We Met The Challenge

By T. L. Mann

In the November 1972 issue, Irwin H. Fust Jr. advocated a number of forms of audio signal processing to allow a higher modulation level and make the sound more pleasing in the article entitled "How To Give Your Program Format Technical Support." Here, Chief Engineer T. L. Mann of WINA, Charlottesville, Virginia, tells how he succeeded in increasing apparent loudness, differing sharply with some of Mr. Fust's recommendations.

WE HAD A PARTICULARLY DIFFICULT apparent-loudness deficiency, as explained more fully below. We had to use modern audio processing amplifiers in the most intelligent way to help alleviate it. We did *not* get usable improvement from the mid-frequency peaking advocated by Mr. Irwin Fust in his article in the November issue of this magazine; that approach simply succeeded in making the signal sound very poor. But we did get a *big* improvement from a change to high-quality condenser microphones that have strong, true, transient response. Here are the details on these experiences.

Apparent loudness is not defined in any reference book, manual, instruction book, or journal that I have seen to date. I shall venture this definition: Apparent loudness is the degree of loudness that one *hears*, rather than the level that an engineer *reads* on test instruments (i.e., a modulation monitor). This commodity is, to say the least, hard to pin down exactly, but it can make or break a station's sound.

When modulation is applied to an AM carrier, as shown in Fig. 1, we can see that amplitude of the carrier wave increased proportionally to the modulation level. In other words, the higher the modulation, the higher the "peak envelope power." Peak envelope power will always be well in excess of the carrier power of an AM station, since the carrier power is specified in the license as being without modulation. The maximum percentage of modulation is limited, however, by practical considerations in the negative direction (graphically speaking, that

---

**T. L. Mann** is chief engineer, WINA/WOMC/AGRINET, Charlottesville Broadcasting Corp., P.O. Box 1230, Charlottesville, Virginia.



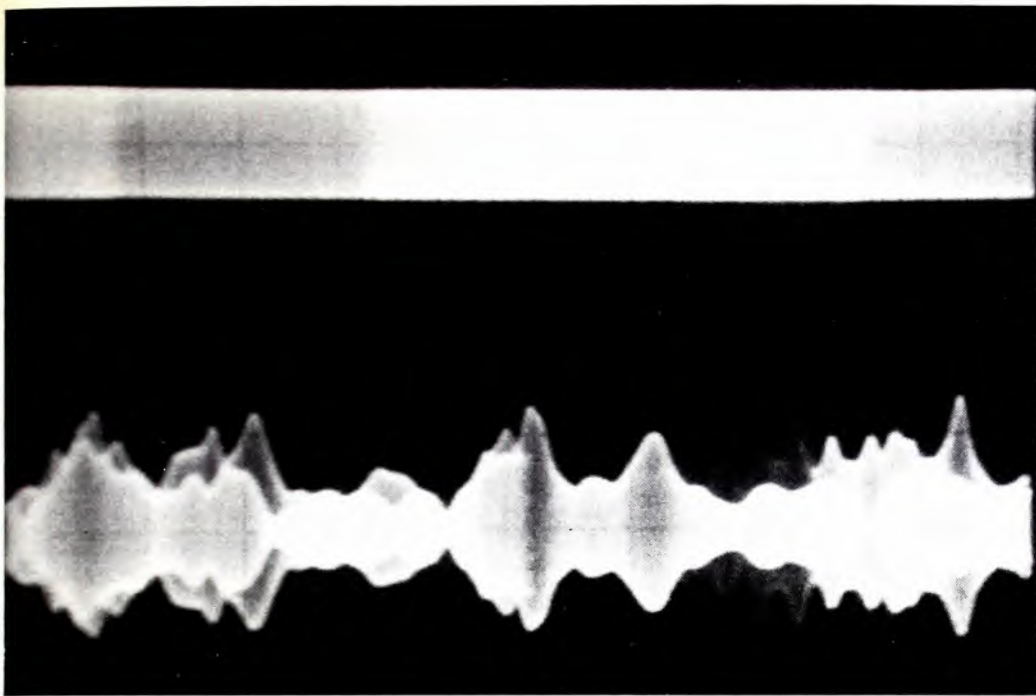

Fig. 1. Dual-trace oscillogram showing unmodulated RF carrier, top trace, and carrier modulated lower trace. Note the higher the modulation, the higher the peak envelope power.

towards the zero line of the carrier); by the fact that at over 100% negative modulation the carrier is clipped for a momentary part of the audio cycle; and, in the positive direction (graphically away from the zero line of the carrier), by a recent enactment by the FCC setting the limit at 125%.

Sophisticated AM processors have become available in the past year or so which allow the positive half of the wave to ride at 124.9% before absolute limiting takes place, while at the same time keep the negative half of the wave at or below 100%. (**Editor's note:** See table of audio processors, December 1972, *BM/E*.) The best units have automatic (and fast in the microseconds) peak switching which inaudibly, instantaneously switch a high negative peak to the positive direction, so it can be limited and used more constructively.

In FM, the carrier has a constant amplitude. The frequency "swing" is the modulation information. The more swing, the louder the signal, up to the FCC limit of  $\pm 75$  KHz ( $\pm 25$  KHz for TV audio). Asymmetry has no level effect in FM broadcasting. What is of indispensable value in FM is a processing amplifier which takes into account the "pre-emphasis" placed on the audio going into the FM modulator. The pre-emphasis boosts the higher audio frequencies in order to overcome losses which affect high frequencies. This means a 10,000 Hz tone will overmodulate an FM transmitter at a lower level than a 100 Hz tone will. The FM "proc amp" takes into account this pre-emphasis to prevent overmodulation in FM.

Audio processing generally falls into five headings: automatic gain control, limiting, compression, clipping, and equalization. Automatic Gain Control (AGC) action is analogous to an electronic hand on

the master gain pot. It carefully raises low levels, and judiciously lowers (gracefully!) high levels. In essence, the AGC "normalizes" levels to a previously set value. Most modern AGCs have a "velvet hand" approach to this process, through the addition of certain features. These are:

Return-to-zero, which tells the AGC "valve" to return to zero expansion/zero reduction when there is no input present for "X" length of time. This prevents the AGC from trying to amplify noise when no signal is present.

"Variable time" means simply that the AGC has a slow expand time and a rather fast reduce time. This is coupled with a slow release time for expansion, and a fairly slow release time for reduction. This prevents the "swish" of early units.

Most modern AGCs have a memory which remembers the *last* input and keeps the degree of control at that point when the signal suddenly ceases, and maintains this control until the time delay runs out for the return to zero function. All of this actually is pretty neat and, to sum it up in layman's terms, it keeps the level pumped up to normal.

Next enter the limiter. I mean here the fast-action *peak* limiter which is used almost exclusively in broadcasting today. The modern, fast-peak limiter is a broadcaster's insurance policy against overmodulation, and is also the route to a higher apparent loudness through the ability to run maximum legal peaks. The peak limiter acts with the force of a sledgehammer to pound down peaks that could overmodulate. It does not affect the non-offending peaks surrounding the offending peak. Most peak limiters today have a "crowbar," or failsafe, device near their output so as to not allow *any* overly-high

peaks through at all. Please color the peak limiter necessary.

Next comes the compressor. Some think the compressor is an unsophisticated AGC; others think it a slow action limiter. I think the compressor is a gain-riding device and, depending on where you ride the compression threshold and input level, the compressor can be both of the above, in a limited fashion. I commonly use compressors to ride gain on a variety of utility functions, such as remotes of one kind or the other, which tend to vary in level considerably. Remember that the compressor is working on the *whole* audio signal rather than just the peaks.

The clipper must be next presented for consideration. The clipper is really a rough form of limiting. If a level gets too high for the clipper, it is simply sliced off by the clipper control elements. Perhaps "sliced" is a mild word to describe clipping. In actuality, the edges surrounding the clipped wave are really rough, as if the offending peak had been actually *axed*. Clippers are seldom used alone. They are frequently employed as those "crowbars" in peak limiters, so their activity is reduced by having the limiter in front. They are the resource of last resort.

Equalization is a different kind of processing than the previous four. It is used in FM and recording in order to overcome certain shortcomings of the medium, but these are fixed equalizations, to be set by the appropriate standards. What we wish to comment on here is using equalizers to "shape-up" program material for cosmetic purposes.

Mr. Fust suggested in his article boosting the "presence bands" in order to achieve more apparent loudness. I strongly disagree with him here! In the first place equalization cannot take place on a fixed basis, since every station announcer sounds different. Secondly, to ask one of today's non-technical operators to make adjustments to an equalizer is not only adding more than he can do, but foolhardy as well! To compensate for these variances, I suggest instead the CBS Dynamic Range Compensator, which instrument acts continuously and variably in this presence band.

As far as AM pre-transmitter equalization is concerned, I have done quite a bit of experimenting on this subject and have come to the conclusion that flat and distortion-free performance is the best. I tried Mr. Fust's 100-7500 Hz bandpass and peakings, and found that the station sounded as if it were being transmitted, if you'll forgive the hyperbole, through a dixie cup and length of string rather than a \$20,000 transmitter.

Since we possess an Advent Graphic equalizer, I was able to try a number of different peakings and whole families of curves. None sounded better on the air than flat. I judged things through two receiving media: one a \$25 table radio, the other an automobile radio. I used a high-fidelity receiver and a small, cheap transistor portable only to verify fringe results, since the table and auto receivers are

the most used. All these test receivers were new within the last year or so, and were transistorized. Moral: Even on modest receiving sets, you can hear a *better* sound with flat transmitter and system response! As an afterthought, hasn't equalization always been a corrective rather than a cosmetic processing medium? If special effects are desired, or unusual colorations requested, both should be performed in the production studio and committed to tape. For the transmitter, the regimen of flat response, minimum distortion, and low noise should be followed.

Generally, contrary to some opinion, all processing equipment should be set up according to the manufacturer's instructions. Failure to do so almost always results in either inconsistent or disastrous results. One manufacturer, CBS Labs, has a test record which is especially helpful in setting up AGCs and limiters. The particular cut of interest is a peaked calibration signal which is a 100 Hz continuous tone, with 3KHz bursts several milliseconds apart. By long experience with this set-up aid, I can tell you that this is as close as I've been to "synthetic" program material which has an average peak content like that of regular programs.

We have had special problems with apparent loudness, because we don't sound as loud as the other two stations in the market (AM). We are a 5kW fulltimer, DA-N, while the others are respectively a 1kW day, 250W night; and a 5kW DA-D, 1kW DA-N. Both of the other stations have transmitter plants right in town, while we are several miles out in the country because of night pattern location requirements. We have a long telco line, which is not conducive to good transient response.

In our manager's words, we sounded "soft" in comparison to the competition. We particularly suffered when the control room mike was open. It was an old standby, an RCA ribbon. I tried several dynamics, but they were as bad or worse, and even a cheap condenser, but the distortion was intolerable.

Finally, I bought a Neumann U-87 for the control room and the world changed. I examined the modulated envelope with condenser and non-condenser microphones. It was obvious even at first glance that the condenser produced a cleaner sound and that all of the transients came through nicely, producing 124.5% positive peaks and good 99.5% negative peaks. The sound is just so obviously *cleaner* on the air that our "softness" problem has been solved to a great degree, though it will obviously never be the same as if we were located right in town with either a short or, better yet, *no* telephone line to go through.

As a result of this experience, we are beginning to convert the entire facility to Neumanns over a period of time. Phantom powering (48V supplies are readily available and, in many cases, 48V is already in the house) makes further economies while still using the best.

**BM/E**



# Canon offers the perfect zoom lens for the camera of your choice

P10 x 20B1



P17 x 30B1



P17 x 30B2



PV10 x 16B



PV17 x 24



PV10 x 15

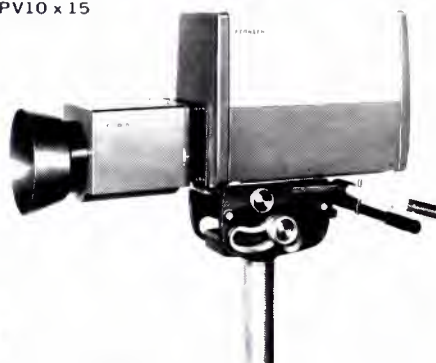

More and more people are discovering how significantly superior Canon Zoom Lenses are for TV broadcasting purposes. Their outstanding color characteristics, even in dim light, is one of the many reasons why Canon was chosen for telecasting the Munich Olympics. Canon's wide range of excellent zoom lenses encompass three types of operation control— all-servorized, via flexible cables and by effortless push-pull rod control. And it can be attached to

fit and operate with any make of TV camera. Shown on this page are only a few examples of the quality lenses Canon has available to more than meet your particular demands. Specify Canon to stay ahead.

The following are Canon TV Zoom Lenses for the Plumbicon® color cameras currently available on the market:

Size of image tube	Lens	Image format covered
1 1/2" Plumbicon® color camera	P10 x 20B4	17.1 x 12.8mm (21.4mmφ)
	P17 x 30B1	
	P17 x 30B2	
1" Plumbicon® color camera	PV10 x 16B1	12.8 x 9.6mm (16mmφ)
	PV10 x 15B2	
	PV17 x 24B1	
	PV 6 x 18B1	

® Reg. TM N V Philips of Netherlands.

#### The Canon TV Lenses Naming System



Applications	Image Format	Pick-up Tubes
P	21.4mm	1 1/2" Plumbicon
PV	16mm	1" Plumbicon

Apart from the above, Canon has available TV zoom lenses for 3" or 4-1/2" image orthicon cameras and can also build special lenses to fit your requirements.

# Canon

● CANON U.S.A., INC.: 10 Nevada Drive, Lake Success, Long Island, New York 11040, U.S.A. (Phone) 516-488-6700 ● CANON U.S.A., INC.: 457 Fullerton Ave., Elmhurst, Illinois 60126, U.S.A. (Phone) 312-833-3070 ● CANON OPTICS & BUSINESS MACHINES CO., INC.: 3113 Wilshire Blvd., Los Angeles, California 90005, U.S.A. ● CANON AMSTERDAM N.V.: Gebouw 70, Schiphol Oost, Holland ● CANON LATIN AMERICA, INC.: Apartado 7022, Panama 5, Panama ● CANON INC.: 9-9, Ginza 5-chome, Chuo-ku, Tokyo 104, Japan

Circle 144 on Reader Service Card

# Quick Success On The FM Band: Getting All Around Town Pays Off For New Station

WDDD, FM stereo operation in Marion, Illinois, hit the black in two months by going out of the studio to get going the local news, by automated programming of country music, and by intelligent advertising policies.

WHEN WDDD WENT ON THE AIR in Marion, Illinois, in November 1970, the independent FM station was up against two high-power AMs, a local cable system, and a brace of local newspapers.

Two months later the station was in the black and has stayed there ever since.

One of the main elements of that success, according to Dutch Doelitzsch, president, has been the management's determination to become the "hot" news station, known through the town as the one present at, and aiding with air coverage of, a wide range of important community activities. To get this go-everywhere capability, WDDD invested in a Ford Super Van and equipped it with a Marti remote radio link. Broadcast-quality signals can be fed into the studio from as far as 25 miles away. Important remotes go on the air live, switched in between the country music programming that is the station's staple fare.

The latter is nearly 100% automated, but preserves a "live" character with expert announcer and skillful disc jockey talk recorded to surround the music. As in a number of other stations, the resulting air product sounds more "live" than that of many non-automated stations; the quality depends essentially on the personalities of the five disc jockeys, and on the expertise of Program Manager P.

D. Schmidt. Getting it all down in advance allows the program department to produce a sound that is smooth and seamless, as well as lively.

Automation, says Mr. Doelitzsch, is one of the keys to the station's success. "The announcer . . . does . . . everything a live announcer does, except that our announcer is doing other things while he is on the air, such as selling, production, news, copy, and so on," said Mr. Doelitzsch. "All this requires about 2½ hours per week for the announcer to prepare his material for automating. . . . Visiting broadcasters can't believe that what they hear is actually automated."

WDDD's emphasis on community involvement goes far beyond the usual alertness to local news. The station, with its remote pickup, becomes a participant in all important local events. The Ford Super Van and the station personnel make the station visible at such events, which reinforces the image of the station as the one to follow for local news. In a recent week, WDDD picked up, live, the following:

- Three high school baseball games
- High school all-sports banquet
- Senior Citizens Convention keynote address
- A riding lawn mower clinic.

As many as five important remotes have been aired in a single day, but the average is roughly one a day.

This activity has already succeeded in convincing a large number of people that if they want to find out about something that is happening in town, they had better tune in WDDD. Mr. Doelitzsch says. This leadership among the media in the community is ". . . an enormous help in our sales efforts. Wouldn't you want to go with the winner?"

The equipment and personnel costs of the remote operations are both high: a professional broadcaster obviously has to be on hand to handle each assignment. "If our remote coverage were a complete loss, we would still do it for the reasons already mentioned, but at WDDD we make money on our remotes." The method is a sponsorship plan, under which a local businessman can pay \$25 each three months, and get mentions—not ads—a specified number of times on remote broadcasts. The plan has proven highly popular with the sponsors

## New Equipment Line-Up For New Sound

Shortly before the accompanying story was written, WDDD moved into new, carefully-planned headquarters with a fresh equipment line-up. Equipment was chosen for the top "sound" the management wanted: Gates Statesman console; QRK turntables; phono cartridges and preamps are Shure; tape cartridge equipment is ITC; open-reel tape units are Ampex and Scully; automation is Schafer; compressor/limiters are Marti. The monitoring equipment is Gates; main transmitter, CCA; and auxiliary transmitter, RCA. With a hilltop location, they are getting "good" signal reports up to 90 miles away.



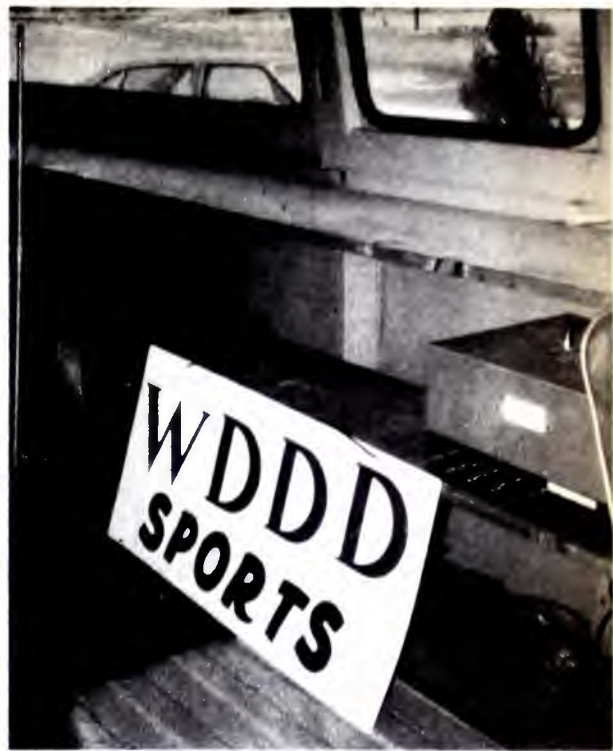

Inside (right) and outside of the WDDD news van, which can be dispatched in a few minutes to any news location to send back broadcast-quality signals from anywhere up to about 25 miles from the station. The Marti transmitter, visible on shelf at right in interior, is equipped with beam antenna in rear of van (left of picture) for the longer remotes. The attractive van makes the station highly "visible" at town events.



Getting the on-location news: Governor Dan Walker of Illinois (left) is interviewed by WDDD news director Steve Land at the dedication of man-made Rend Lake.

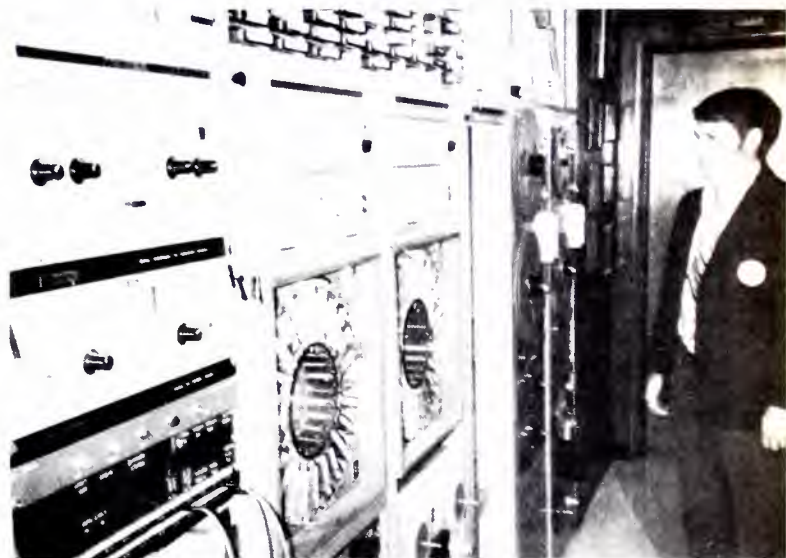

President Dutch Doelitzsch stands next to the Schafer automation gear used to put "seamless" but lively programming on the air.

and gives WDDD freedom to use remote pickups as needed. "After all," says Mr. Doelitzsch, "who can pass up an advertising package that costs only \$8.33 per month? Everybody wins . . ."

A further element of community involvement is the availability of WDDD air personalities as masters of ceremonies for clubs or other organizations. "They do this as part of their regular duties," says Mr. Doelitzsch. The programming also includes a good number of local "talk" shows, on which personnel of local groups can be interviewed to tell the

community about what they are doing.

WDDD put on its first quad broadcast in November 1971, raising considerable local interest. But the station has not yet put much emphasis on this because there is very little country music recorded in quad.

A last note on the special character of WDDD: at the time it went on the air, in November 1970, no member of the management or technical staff was older than 23! Give these youngsters ten years and they will zoom clear out of sight. **BM/E**



**YOU ARE WASTING  
TIME AND MONEY  
IF YOU TAKE MORE THAN**

SEE US  
AT OUR  
NAB BOOTH 109  
SHERATON PARK

**5 SECONDS  
FOR THIS  
SHOT SEQUENCE**  
USING ONLY ONE CAMERA

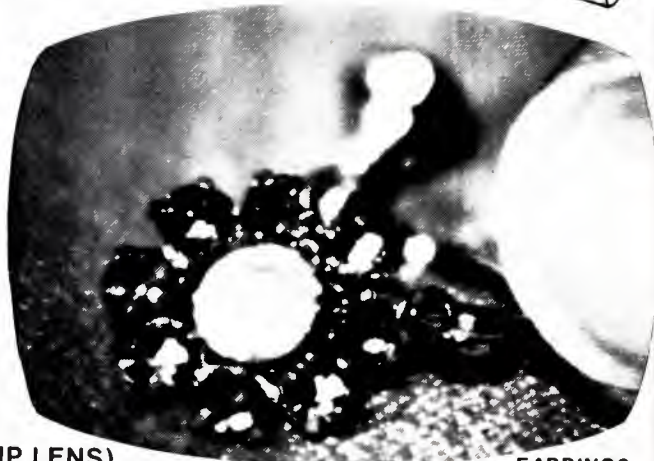

675mm (NO CLOSE-UP LENS)

EARRINGS



18mm (VERY WIDE ANGLE)  
(FROM ONLY 6 FEET AWAY)

SMALL STUDIO

**CONFIDENTIALLY  
ONLY THE  
angēnieux 15 to 1  
CAN DO THIS FOR YOU!**



675mm (375 to 1 RANGE AT  
THE PUSH OF A BUTTON)

CUFF LINK

**angēnieux** corporation of america  
440 merrick road, oceanside, n.y. 11572 • (516) 678-3520

Circle 145 on Reader Service Card



# VIDEOSKOP & SIDEBAND ADAPTER to MEASURE VIDEO SYSTEMS WITH COMPOSITE SIGNALS.

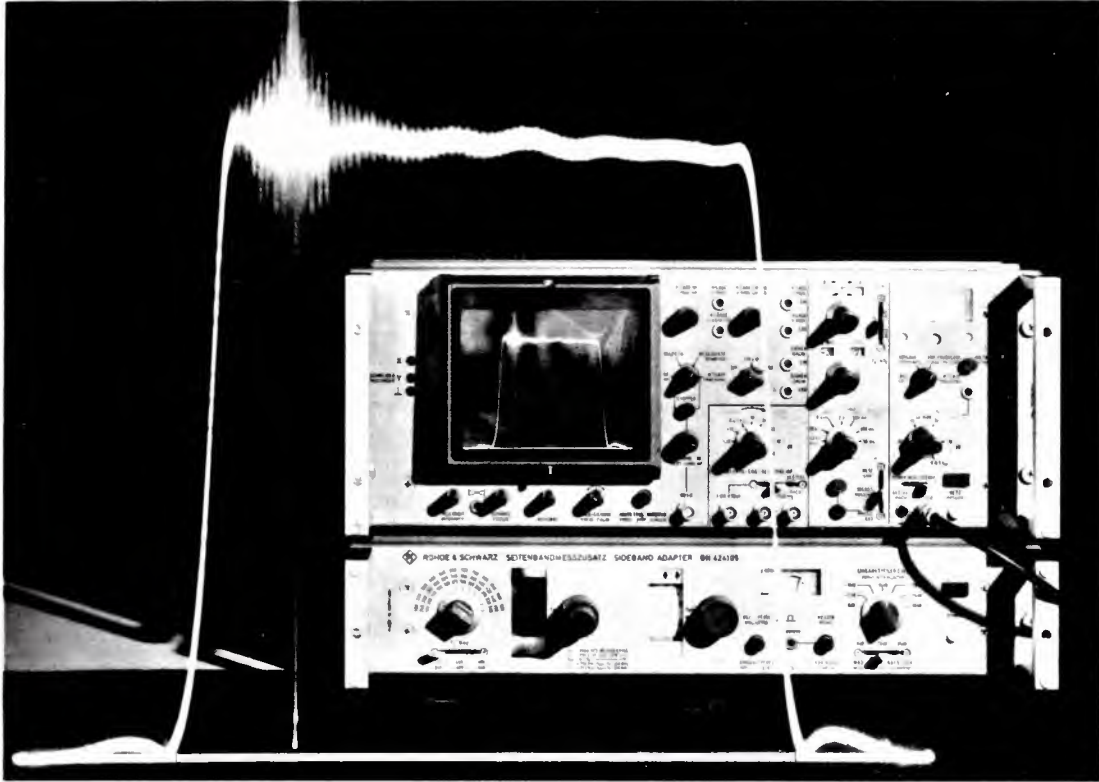

## FEATURES :

Complete test system : Sweep Signal Generator, Selective Tracking Receiver (2 kHz BW), large screen display, in a single cabinet. 75  $\Omega$  VF, 50  $\Omega$  RF.  
Freq. Range : 10 kHz-20 MHz or

with sideband adapter 30-1060 MHz  
(display -10 to +20 MHz about carrier)

Sweep :  $\Delta f$  sweep  $\pm 100$  kHz to  $\pm 1$  MHz  
50 ms to 80 s (X-Y Recorder Output)

LIN (30 dB) and LOG (50 dB) display with 30/50 dB dynamic ranges.

LIN x 10 range with resolution better than .01 dB.

Use as sweep source and plotting detector with R/S Type LFM Envelope Delay Test Set.

Chopper operation for simultaneous presentation of two input signals, e.g., frequency response, envelope delay.

Double control facility in display section for magnification of a particular section of frequency response.

## APPLICATIONS :

Display of frequency response and envelope delay on VF system in presence of sync/blanking pulses (sweep with composite video).

Measurements on transmission links (with tracking receiver).

VIT measurements

Sideband analysis 30 MHz to 1060 MHz (with sideband adapter).

Spectrum Analyzer

## MEASURE

Absolute and relative amplitude-frequency response  
Return loss

Sideband characteristics of TV Picture Transmitters  
End-to-end transmission characteristics on cables and radio links

Characteristics of TV Receivers, Demods, Filters and Amplifiers

Simultaneous Frequency Response and Envelope Delay

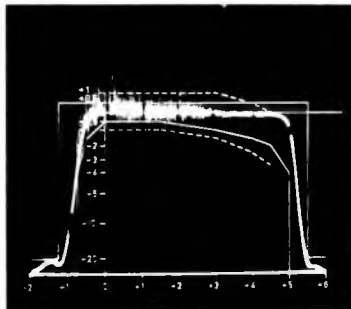

Display of sideband characteristic of a VSB TV channel Signal Generator (SBTF). Test requirement : sweep signal component in composite picture signal 10% of picture signal, set-up at picture white. Combining swept-frequency operation with analysis permits the test signal to be easily observed and measured between the spectral lines.

Videoskop is a highly reliable solid state visual display sweep frequency system covering the range of 10 kHz to 20 MHz. A sideband adapter is available to include VHF and UHF up to 1060 MHz and permits measurement of sideband characteristics to within 10 kHz of TV picture carrier. Type SWOF III Videoskop provides an automatic display of the amplitude response of a test item instantaneously. There is also a facility for manual sweeping (point by point tuning) for use as a CW signal generator. Level meter, calibrated switchable/continuously adjustable input and output attenuators and marker generator permit absolute measurements. Selective tracking receiver makes possible plotting of characteristics of TV systems in the presence of sync and blanking pulses. It further eliminates errors due to harmonics and can be used as a spectrum analyzer. Measuring range is -100 dB to +70 dB. Chopper operation is available for simultaneous presentation of two input signals, e.g., frequency response, envelope delay with Type LFM Envelope Delay Test Set. The display section has double control facility for magnification of a particular section of the frequency sweep. The long sweep time (adjustable from 50 ms to 80 s) is used for test items with long delay times or for use with an X-Y Platter. Accessories available : Tracking Unit for link measurements, Precision Freq. and Marker Generator, adjustable to 1 kHz throughout sweep range and displayed to 5 digits.



Get The Extra Capability,  
Greater Reliability, and  
Longer Useful Life Of . . .

## ROHDE & SCHWARZ

111 LEXINGTON AVENUE, PASSAIC, N. J. 07055 • (201) 773-8010

See us at NAB Booth 312

Circle 146 on Reader Service Card

# Tape-Athon

# THE INDEX OF PROFESSIONAL STUDIO EQUIPMENT

Model 900

## LOGGER

Tape-Athon's broadcast **LOGGER** is ideal for radio stations and communications centers, combining performance, dependability and low investment in a field-proven unit. Speeds down to 15/32 ips permit 409 recording hours per channel with up to 8 channels / 8 tracks available.

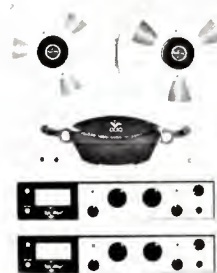

LOGGER

Model 900

## RECORDER

A truly professional recording system, the 900 will perform virtually any audio assignment in the studio. Mechanically and electronically the 900 has proven itself in hundreds of installations. Uses all reel sizes to 10½", has dual capstans for smoother tape movement, 30 to 15,000 Hz response, sensitive to 25 Hz cue tone and speed combinations of 3¾-7½ or 7½-15 ips. It operates so smoothly it can handle ½ mil tape.

The 900 is also ideal for use as a playback unit in automation systems. Electronics are all solid state, it has automatic reversing, instantaneous start/stop, and reel torque compensation.



RECORDER

## MULTIPLEXING

Here's a pair of easy ways to broadcast background music for fun and profit. Tape-Athon's **PROGRAMMER** and **CHANNEL CASTER** both have 4 tape transports with a capacity of over 800 different musical selections. With the **PROGRAMMER** you have built-in timing circuits that permit an infinite variety of mixing for specialty music during the broadcast day. It's complete with 7-day ON-OFF clock, VU meter, monitor speaker, and 40 watt amplifier. The **CHANNEL CASTER** is equipped with six inputs and an intersperser to mix music and ads or other spot announcements. Both are available with Tape-Athon's extensive music library on a sale or lease basis.

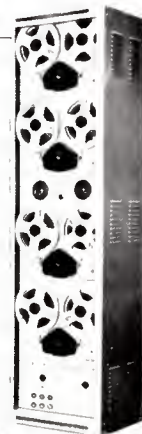

MULTIPLEXING

## AUTOMATION

This low-cost Tape-Athon **CHANNEL CASTER CAROUSEL** allows any station to automate for a modest investment. The CCC is a two-tape transport system (expandable) with a cartridge Carousel unit that can be interspersed with the music. This allows local ads to be aired with news, weather, ID, or any other promo material. This complete program package is priced at only \$4285.00 in mono and \$5285.00 in stereo.

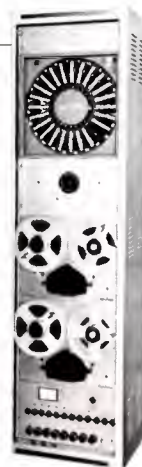

AUTOMATION

# Tape-Athon Corp.

502 S. Isis Ave., Inglewood, Calif. 90301 • (213) 776-6933



# WCVB-TV, An All-Digital Station—No Other Way To Go

"If things are ever to move upward, someone must take the first step and assume the risk of it." — William James

A quote used in the dedication announcement by WCVB

BOSTON STATION WCVB-TV, channel 5, which is one year old in mid-March, is not just a station; it's a pioneer. The Big Screen now streams continuous images of two, mostly digital, live-action programs.

After many months of development, the station's new programming, including a new 11:30 a.m. program called "Weekend Update," is now on the air. It took the air on Sunday, March 22, 1993.

The station's new programming is made possible by modern equipment. When the station was built, it had a list of 100 equipment suppliers. Today, only "Who's Who" at some museums and a few other countries, Canada, and France. The rest of the world is all of the new gear that has come on line.

Although there are many challenges, the station's new programming is a major step forward. The station's new programming is a major step forward. The station's new programming is a major step forward.

"There was always a lot of talk about the station's new programming. It was always a lot of talk about the station's new programming.

He says the station's new programming is a major step forward. The station's new programming is a major step forward. The station's new programming is a major step forward.

"We primarily have a lot of digital equipment. It's a great deal of different equipment. It's a great deal of different equipment.

We're having a lot of trouble with the equipment. It's a great deal of different equipment. It's a great deal of different equipment. It's a great deal of different equipment.

The first problem was that the equipment was not working. The staff did not understand the technology. A crash program had to be organized with the manufacturers on site. It became clear that the staff thought that the theory was not being understood by most operators. This meant concentrating on how to localize trouble to a machine. In times past, operating crews acquired a technician to where to kick or poke a piece of gear as an expedient in revitalizing it. Digital equipment does

not have a technician to call.

Most of the station's new programming is made possible by modern equipment. When the station was built, it had a list of 100 equipment suppliers. Today, only "Who's Who" at some museums and a few other countries, Canada, and France. The rest of the world is all of the new gear that has come on line.

Although there are many challenges, the station's new programming is a major step forward. The station's new programming is a major step forward.



Operating a video camera in a studio setting at WCVB-TV. The station's new programming is a major step forward.





the training operation.

Steve deSatnick says to appreciate the scope of that training process you have to imagine each man studying the operation manuals for products entirely new to the industry as well.

"Using digital circuitry is a departure from what most of us had been used to," he explains. "The theory is excellent; reducing theory to practicability leaves something to be desired."

"However if the system is working, the pictures are outstanding and the videomen love them."



Studio A control room. Audio control is on other side of glass wall, right.



Inside audio control room for studio A.



Close-up of switching position for studio A.

deSatnick says proudly.

"Reliability of performance hampered us most in the early going," deSatnick says, although he is not quick to point a finger at any one manufacturer in particular.

It is known though that WCVB still keeps its fingers crossed when it faces a heavy schedule in front of the studio cameras.

Heavily community-oriented, WCVB originates 4 hours of live programming each week. The remainder of the station's schedule is provided by ABC Television. On November 15, WCVB expanded its service to 24 hours Wednesday through Saturday and signs off other days at 1:45 a.m.

The extended hours resulted from staunch community support of the station's programming. Many observers believe WCVB has the superior signal in the area. It was a long time coming, some WCVB engineers admit.

The plant has five Norelco PC-100As, the most advanced broadcast television camera on the market today. And while WCVB says it has not faced a day of down time due to camera performance, the station does say that some of its cameras have spent a considerable amount of time back at the Philip plant to incorporate production improvements.

The PC-100As are outstanding at their best, deSatnick says, and praises their technology as far advanced, but admits that the station and Norelco had reliability problems. Some modules require resetting or replacement. For reasons that were never fully understood by the station, cameras occasionally would automatically switch from the operating mode to standby.

It appears that the solution is at hand. Problems that were attributed to line transients have, for the most part, been solved by some by-pass capacitors. The biggest annoyance, intermittent troubles—that were hard to pin down—seem to have been licked. Circuit design is now frozen and the quality of modules is now uniform.

All of deSatnick's headaches weren't camera alone. He says that the Ampex AVR-1 third generation color video recorders played havoc with the station's crew in the early months.

"There were power supply problems that have been modified and head life problems with the AVRs," he says, but quickly adds, "the AVRs are still the greatest things since copper wire."

One AVR was down for a week when Ampex needed seven days to replace a matched transistor for the unit. Since that time deSatnick has established a working rule that no piece of equipment be down more than 24 hours. To enforce this rule he has a six-man maintenance staff that does not double in operations. "They're constantly putting out brush fires," he says.

In recent months WCVB has overcome most of its operational problems and deSatnick appreciates the help he's had from manufacturers in correcting problems and training. The educational process continues today and WCVB is sending some of its engineers to school to learn more about the sophisticated equipment.

There is more time now to talk lavishly of th



station's newness and its avant garde operation. The large items of equipment include two Norelco 17.5 kW transmitters with solid-state low-power stages and IF modulation; an RF switching system; an RCA five-bay butterfly antenna; five PC-100A cameras, a Norelco PCP-90 portable video camera; three film islands, each with two 16mm projectors and a slide projector; four AVR-1 and two Ampex VR-1200 tape machines; one Ampex slow motion recorder and one Ampex RA-4000 electronic editing unit; and the production control room, master control room and tech center consoles and racks. The RF switching complex permits 11 modes of operation between the dual transmitters and the 3/2 antenna. The Central Dynamics Ltd. master control switcher is planned for on-line, real-time computer control.

Later a computer-controlled station-automation system will be incorporated into the present switcher which will embody a number of interconnected, job-oriented programs.

Steve deSatnick calls the CDL master control switcher a stout performer. He adds that anyone not using an IF modulated transmitter is behind the times. He talks freely about operations at the station, although the plant's purchasing had been completed by the time he arrived in Needham in August 1971, and he's not trying to defend his decisions.

In detail, the CDL video switching equipment in master control includes a 24 x 4 video/audio switcher with special effects and background generator and a 17-event memory and machine control system. A four-channel audio mixer, four audio cartridge machines and one reel-to-reel audio tape machine are also contained in the console. The remote control panel for the studio transmitter is located in the master control room as is the Leitch pulse delegation and tally switcher.

The station has a production center and a post-editing center that house the videotape equipment including four AVR-1 and two VR-1200 videotape recorders, one Ampex slow-motion recorder and the Ampex RA-4000 electronic editing unit with a CDL 15 x 8 video/audio switcher for use with the 4000.

By combining the two, wcvb feels it gets benefit from taping and playback sessions, while at the same time permitting post editing in a separate room under quieter conditions.

In January 1974, wcvb expects delivery of the new Ampex ACR-25 video cartridge tape machine.

The physical layout of the studio building gives a spacious appearance, although wcvb officials say they are becoming increasingly cramped in their 55,000 square feet location.

There is constant construction underway within the building. The original layout has changed somewhat over the first year of operation, but basically wcvb operates with a 40 x 30 x 16-foot-high news studio, with adjacent news room including a 16mm film processor, TWX room and film editing room, as well as offices and news conference room.

A 20 x 24-foot production control room is now being modified to include a smaller second room, and the main studio, 40 x 60 x 22 feet high, is positioned adjacent. Both the news studio and the



VTR room has four AVR-1 and two VR-1000 Ampex videotape recorders. Ampex RA4000 editing console is in foreground.

Master control console is a Norelco design with CDL 17-event memory control unit.



main studio have a unique floating floor and a resiliently-supported, hung ceiling to exclude external noise.

The technical area is completed by the tech center, master control room, a scenery storage room, dressing rooms, film editing spaces, program department offices, and master control room.

The station has 8400 square feet additional space which houses carpentry, the air conditioning plant and garage space for the mobile vans.

The station is temporarily using a full-sized video van as a second control room until construction within the plant is completed. Wcvb uses a second van, a mini-studio on wheels which contains a PCP-90 and the Ampex VR-3000 portable video recorder, for on-location work. (See *BM/E*, January 1973, for story on election night coverage around Boston by wcvb.)

Looking back at the early problems, most of wcvb's station planners would agree with a point deSatnick is quick to make. "We could have gone with proven equipment. That would have solved a number of problems earlier. Digital equipment is nothing to fear; in fact it's the only way to go.

"The crew responded admirably to a special situation," deSatnick says.

It's time for praise. For the most part the engineers have reached a more comfortable period. Working with the equipment and maintaining the operation has become an easy job.

"No other way to go," station planners say today with a glint in their eyes. Perhaps there is still the memory of the days when the combination of new technology, solid state electronics, and digital operation posed some tense moments for Boston's wcvb, channel 5.

**BM/E**



# You have to carry it to believe it! A 38-pound broadcast color portable VTR costing far less than Quad.



Our new Model 201C record/only VTR meets all quadruplex color broadcast levels of performance. Only the color electronics are new. In the last three years the tape transport has flown millions of tough environmental miles for the military. It's been there and back.

We'll not load this message with tech details but instead invite you to a live demo at the 1973 National Association of Broadcasters Convention.

There's more good news in helical recording.

We'll also demonstrate our new studio Model 411C record/reproduce VTR. It, too, meets the same high levels of broadcast color performance of all the big, expensive VTR's. Superior tape handling, continuous time base and velocity correction plus

insert and assemble editing are standard features. There are, however, major differences.

Our machine costs far less than Quad and weighs only 140 pounds. What has happened is that the 411C makes possible and practical a compact remote capability in a station wagon. And, going right down the list, we save you at least 60% in original purchase and operating costs.

If the potential of these new VTR's boggles your mind—wait until you see the full story.

Contact our Director of Broadcast Video Marketing. Telephone 415/961-7145.

## ECHO SCIENCE

485 E. Middlefield Road, Mountain View, CA 94040

Circle 148 on Reader Service Card





# BROADCAST EQUIPMENT

**Power supply** for headend or microwave applications has standby for continuous operation without delay or transfer time. Model 1600 has inverter stable to .03 Hz, works from 120-volt, 60 Hz sine wave, or for 108-volt DC automotive or stationary batteries. INTERSTATE TEL. AND ELECTRONICS 275

**Electronically-tuned oscillators** cover octave bandwidths in five units over range 32 MHz to 1 GHz. LTO Series has tuning linearity and tuning accuracy to  $\pm 1\%$ . Output is 20 mV, fully isolated for stable operation into VSWR's up to 10:1. Tuning voltage may be modulated up to 1 MHz. \$390. to \$475. TEXSCAN CORPORATION 276

**Tripod head** handles cameras with high or low center of gravity. Model EC is a "Hydrofluid" head for Eclair



NPR and conventional cameras. It has built-in level, full pan and tilt. NATIONAL CINE EQUIPMENT 277

**Counter** measures frequency 0.001 Hz to 2 MHz. Model 6220 can resolve 0.001 Hz in one second, uses a phase-lock technique for rejection of random noise, has AGC that sets all output adjustments for total hands-off operation. Digital readout has auto-ranging decimal and leading-zero suppression. Measurements are also available in 4-bit BCD parallel output. \$350. SYSTRON DONNER 281

**Broadband multi-channel microwave receiver** can process up to 40 video channels in the VHF band. AME broadband receiver permits full use of

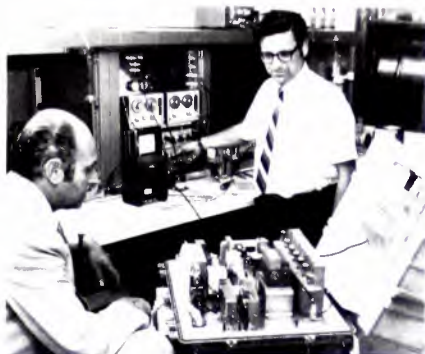

mid-band and super high-band channels, as well as standard VHF channels, with low inter- and cross-modulation. THETA-COM 279

**Character generators** have keyboard entry, keyboard-controlled word flash, audio tape storage, two-speed horizontal crawl. Model D-2400 has simultaneous two-channel display and four-page display memory. Model D-1500 has smaller character size, single channel. From \$4000. DATAVISION, INC. 280

**New videotapes** are available with non-back-coated gamma ferric oxide, back-coated gamma ferric oxide, back-coated cobalt high energy. QVII video-



tape comes in 1/2 in., 3/4 in., and 1 in. widths. QUALITY VIDEO INDUSTRIES 284

**Wireless teaching-aid system** consists of small transmitter and any number of pocket-sized receivers. WTA-10 system can transmit recorded tape or

instructor's voice to student carrying a receiver. \$495. (with 10 receivers). RHA AUDIO COMMUNICATIONS CORP. 282

**MATV amplifiers for VHF/FM** has separate gain controls for low-band and high-band channels to balance output. Model CVB-30A handles both strong and weak signals, has maximum gain of 35 dB on low-band and FM, 33 dB on high band, noise figure 8 dB, output maximum  $> 52$  dBmV per channel. BLONDER-TONGUE LABORATORIES 283

**Hand-held detector** allows location of low-level sources of RF noise. The "Sniffer" picks up magnetic fields at discontinuities on surface carrying RF current. A dB meter, built-in loudspeaker, or plug-in headphones all indicate presence of the interference. The one-and-a-half foot arm can be extended for sniffing in tight locations. Battery operated; weight two pounds. SINGER INSTRUMENTATION 285

**Data display unit** has full-screen memory, central timing, and a serial ASCII input. Model CG105 has internal sync for RS170 color or mono composite video signal; 512-character memory for up to 16 lines of 32 characters each. \$595. VIDEO DATA SYSTEMS, INC. 286

**Automatic background-music system with announce programming** is designed for cable TV use. The "Channel-Caster Carousel" has two open-reel tape playback transports for the music programming, and a rotary tape cartridge mechanism that holds 24 message cartridges, all in a standard 77 in. rack. Music programming and insertion of messages on a random-select basis can be preprogrammed for a full day, with completely automatic operation. TAPE-ATHON CORPORATION 287

**FET probe for wideband oscilloscopes** allows measurement of low-amplitude signals to 220 MHz without appreciable circuit loading, can be used on scopes with intrinsic bandwidth to 150  
continued on page 86

For less than the price of a small console you can own the whole studio.

# mini studio



## LAMB

See us at the NAB Booth 560 Shoreham Hotel

**Put your money where your mouth is.**

Sharp words. But sound advice when you're choosing a microphone for voice recording.

And when it comes to faithful voice reproduction in the most demanding recording and broadcast situations, we don't know of any microphone that can compare with our Beyer M 160.

The unique double ribbon design of the M 160 can unerringly reproduce the most subtle nuances of speech and music. And its super cardioid pattern assures superb front to back discrimination while rendering the M 160 almost immune to feedback.

Naturally, this kind of quality and performance doesn't come cheap. The Beyer M 160 costs \$180.

But when you think about it, that's a small price to pay for never having to say you're sorry.

**Another innovation from Beyer Dynamic, the microphone people.**

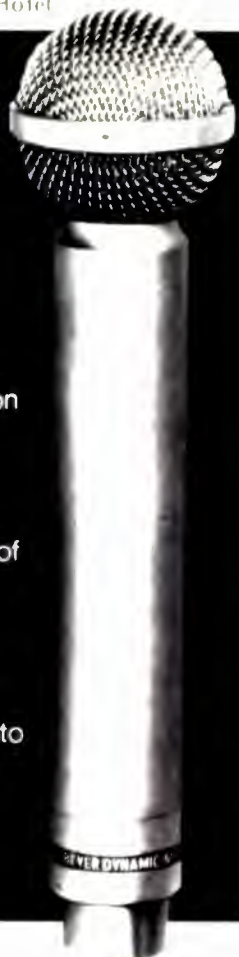

Revox Corporation 155 Michael Drive Syosset N.Y. 11791

Circle 150 on Reader Service Card

## PRODUCTS

**MHz Model PM9353** has input impedance of 3.5 pF in parallel with megohm, dynamic range of  $\pm 1$  vol drift under 1 mV/day and broadband noise under 0.5 mV. **TEST AND MEASURING INSTRUMENTS (PHILIPS)** 28

**FM coupler** is for insertion in VHF circuit, has bandwidth  $\pm 300$  MHz. Model 95 supplies VHF rejection of the FM tape of 25 dB, has negligible through loss. **MAGNAVOX CATV** 28

**Production titler** has 10-14 character matrix characters in standard character height, 10th row title only mod for quick access to 16 titles. Model PT 3200 has roll and crawl mode.



two read rates, consists of a small keyboard and separate 3 1/2 in. by 19 in. rack-mount electronics unit. \$399. **MSI TELEVISION** 29

**Tape recorder and reproducer** has three speeds, ferrite heads, plug-in head assembly. Model 7202 has flu-



continued on page 8



# Spotmaster

What's a turnkey studio? It's a completely equipped radio broadcasting center, with all the equipment available from one source: Broadcast Electronics.

We supply anything and everything . . . from mikes to phones . . . from top quality Spotmaster® cartridge tape equipment (more than 30 different models) to the clock on the wall. Plus consoles,

record playing equipment, accessory audio devices, reel-to-reel tape decks, storage systems and modern control room furniture.

OUR NEW BROCHURE shows and describes every type of equipment to be found in the Spotmaster turnkey studio. Write or call for your copy now.

## INTRODUCING THE TURNKEY STUDIO



SEE THE TURNKEY  
STUDIO IN BOOTH 107  
AT THE NAB SHOW

**BROADCAST ELECTRONICS, INC.**

A Filways Company

8810 Brookville Road  
Silver Spring, Maryland 20910  
(301) 588-4983

# Bon·ne·ville, \bän-ə-vil\ n:

1. inside track to success in today's adult music competition. 2. Bonneville Program Services. 3. the team that puts music in your air and money in your pocket.

## Sound good to you? See us at the convention.



Bonneville Program Services

485 Madison Avenue, New York, N.Y. 10022 (212) 371-3400

## You won't believe what we did to the TAPEX cartridge.

We threw out pressure pads for starters. Big deal? You bet it is. Because pads cause unnecessary wear on the tape and heads. With Tapex, you get longer life on both.

So now you ask, "how do you keep the tape on the head?" Easy. Tension is set on each Tapex Cartridge at the factory. And a unique stereo phase stabilizer keeps the tension just right during use.

This is just one way we've made Tapex a little better. Find out the rest. Write for details today.



**TAPEX MEETS ALL NAB STANDARDS.**

Tapex Corporation/P.O. Box 796/West Des Moines, Ia. 50265

YES! Please send me a detailed Tapex Cartridge flyer and price list.

Name \_\_\_\_\_

Address \_\_\_\_\_

City \_\_\_\_\_ State \_\_\_\_\_ Zip \_\_\_\_\_



**TAPEX CORPORATION**

BME-3

Circle 152 on Reader Service Card

## PRODUCTS

ter and wow at 0.04% at 7.5 ips, solenoid-operated tape lifters. SCHAFER ELECTRONICS CORP. 291

**Portable TV production center** accepts inputs from three cameras and a VTR. "Mini Console" also has built-in spe-



cial effects generator, four-input audio mixer, and three 5 in. monitors. GBC CLOSED CIRCUIT TV CORP. 292

**Voltage surge protectors** use gas-filled three-electrode tubes which instantly ground both sides of line with an over-voltage. Series 167 protectors have both gaps in one envelope, so both sides ground out simultaneously, preventing development of "line-to-line" voltage. Breakdown time is 0.3 micro-second, with no breakdown at 500 vDC, firing at 620 vDC. Gap carries 50 amps for 2 seconds, 7 amps indefinitely. CARDION ELECTRONICS 293

**Zinc coating material** forms a rust-resistant coat on any metal. "Zinc-It" can be put on cold, provides nearly the same protection at hot-dip galvanizing. CRC CHEMICALS 294

**Wideband amplifier** carries from two to seven color TV signals, plus FM, in the 6-48 MHz range, for more than 40 miles in a 32-amplifier cascade. "Sub-



Nova" is normally installed in multiple cable systems, with up to eight units in one housing, for 56-channel capacity. Unit gain is 25 dB, noise figure 7.5 dB, cross modulation - 85 dB. Dual pilot-carrier AGC controls level and slope. AMECO 295

**Digital cueing device** provides identi- continued on page 90



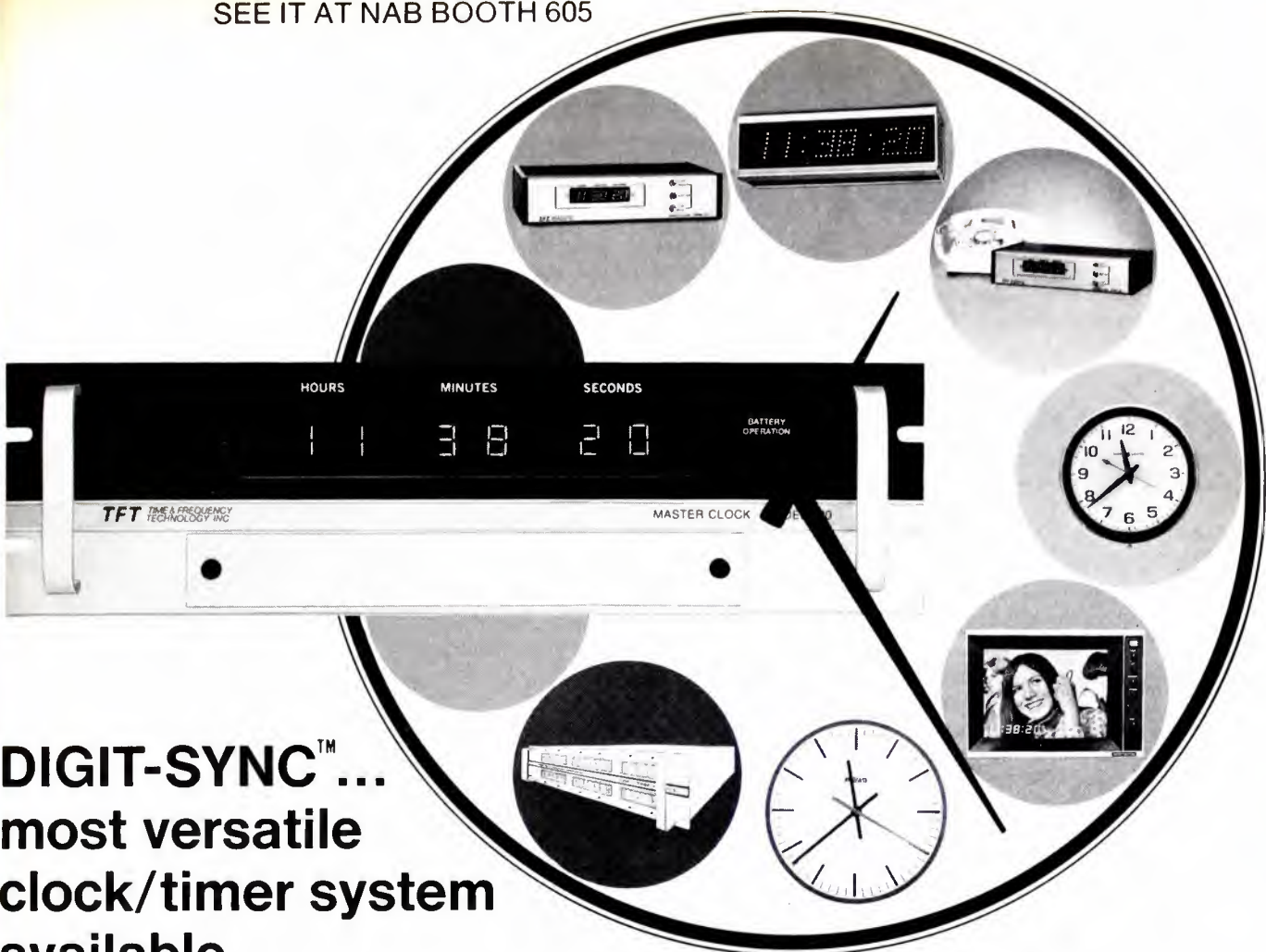

# DIGIT-SYNC™ ... most versatile clock/timer system available

Now, with TFT's DIGIT-SYNC clock/timer system you can synchronize any number of remote digital clocks, impulse clocks, event timers and synchronous motor clocks, and impose time data on a video signal, with an accuracy of one second per month. Or, as an option, three seconds per year.

And installation is easy. Unlike other systems that need more than 20 conductors for remote time display, DIGIT-SYNC uses a single pair of shielded wires to transmit time data and supply DC power to auxiliary units.

In addition, serial time data can be sent over voice band channels,

or recorded on tape for time coding of information.

What's more, you can expand DIGIT-SYNC into a system of virtually any size or complexity. Power failure protection is provided by a 12-volt back-up battery.

## ... plus the growing line of TFT frequency and modulation monitors

Since the first TFT monitor was introduced in 1971, TFT has become the standard of technical excellence in frequency and modulation monitoring: more than 350 radio and TV stations now use TFT instruments, with good reason.

For example, all TFT monitors give you remote monitoring without an RF amplifier on the front end. This means less interference from the intermodulation products of unwanted signals. You also get digital frequency readouts, digitally settable peak flashers, exceptional long term accuracy, and unequalled solid state reliability.

TFT monitors comply with all relevant FCC requirements for local and remote monitoring.

For more information about DIGIT-SYNC and TFT's growing line of

monitors (more are on the way) see us at NAB booth 605 in the Shoreham Hotel. Or contact us at the address listed below.



**TFT TIME AND FREQUENCY TECHNOLOGY, INC.**  
3000 OLCOTT STREET, SANTA CLARA, CA 95050 (408) 246-6365

Circle 153 on Reader Service Card



# ALL-IN-ONE SPORTSCASTER HEADSET

This sportscaster can roam about a football field, rubberneck at a basketball game, or quickly position himself for an important golf shot. All with just one piece of equipment. The new Telex CS-90 Sportscaster headset lets him broadcast live (fixed station or mobile) listen to production cues, and monitor his own transmission, all with hands free convenience.

He can do all this because Telex has now combined the finest professional microphone available, one of proven broadcast quality, with an equally high-performance headphone.

This wide-range, dynamic, boom microphone has a low frequency response to transmit his voice clearly and crisply, and an omni-directional design to pick up colorful crowd noise. The two channel headphone fits comfortably with a padded headband and foam filled earcushions to screen out ambient noise. It is adaptable to any application or equipment by means of non-terminating cordage and features exclusive Telex audiometric type driver elements. And both headphone and microphone are designed to stand up even if the sportscaster has to work in all types of weather extremes and can't avoid some hard bumps. In fact, if the broadcaster doesn't hold up as well as the CS-90, there is a "push-to-cough" switch that mutes the mike when necessary.

Constructed of high-impact ABS plastic and stainless steel. Styled in non-reflective black and grey to eliminate glare on camera. Write for further information.



PRODUCTS OF SOUND RESEARCH

## TELEX®

COMMUNICATIONS DIVISION

9600 ALDRICH AVENUE SOUTH  
MINNEAPOLIS, MINN. 55420

CANADA: DOUBLE DIAMETER ELECTRONICS LTD., Scarborough 4, Ontario  
EQUIPMENT: RAYAL SOUND COMPANY, INC., 413 North Main Street, Freeport, N.Y. 11520 U.S.A.  
INTERNATIONAL TELE-EXPORT DEPT., 9600 Aldrich Ave. S., Minneapolis, Minn. 55420 U.S.A.

Circle 154 on Reader Service Card

## PRODUCTS

fication and cueing information electronically. "Digislate" works with both film and tape, has provision for remote control. \$285. AUDIO/VIDEO PRODUCTS. **296**

**Line of vidicon cameras** includes studio and industrial security models. PVC838 is a monochrome studio camera with 1-inch vidicon, 550 lines of resolution, 5:1 rear operated zoom lens. PVC808 is a viewfinder camera with 2/3-inch vidicon and 3-inch electronic view finder. PVC828 is for industrial security; once focussed it needs no adjustment. AUDIOTRONICS CORP. **297**

**Connectors for CATV aluminum sheath cable** include all standard types: entrance, feed-thru, splice, termination, etc., for sizes .412, .500, and .750 cable. RFI suppression is built in, and return loss is given as better than 40 dB. EG&G INC. **298**

**High-power RF transformers** match 50 ohms to 75 ohms, and vice versa. AT-10 Series handles up to 10 watts, average power, between 40 MHz and 250 MHz. Insertion loss is 0.4 dB. \$39.95. ACRODYNE INDUSTRIES **299**

**Clock/timer** will synchronize remote digital clocks, event timers, and synchronous motor clocks, and will also put time information in a video sig-



nal. DIGIT-SYNC has standard accuracy of one second per month, with a crystal reference. Higher accuracy is optionally available. Time information is transmitted to slaves over a single pair of wires, using built-in modems. TIME AND FREQUENCY TECHNOLOGY, INC. **300**

**Eight new video camera tubes** include four image isocons, two intensifier vidicons, one BIVICON, and one vidicon. The isocons, Models 4827, 4827A, 4828, and 4828A, are useful for medical and industrial X-ray applications, or others with large intrascene dynamic range. Intensifier vidicon-continued on page 92



# We threw away the 50 kW modulation transformer and reactor... With PDM,\* who needs them!

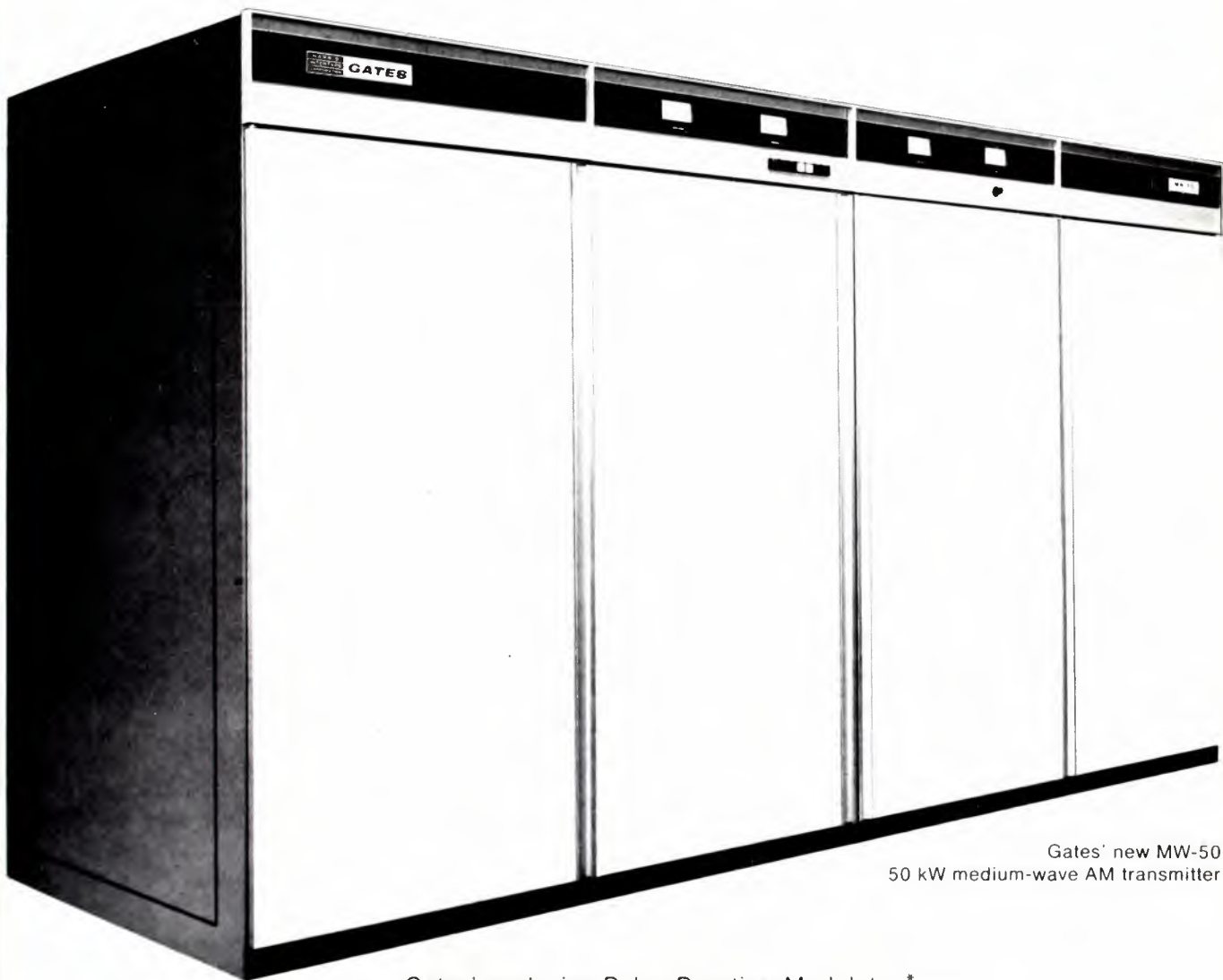

Gates' new MW-50  
50 kW medium-wave AM transmitter

Gates' exclusive Pulse Duration Modulator\* System is 90% efficient. That's why Gates' new MW-50, 50 kW medium-wave transmitter operates at greater than 60% overall efficiency. With greater reliability, greater frequency response, and lower power consumption than any other AM broadcast transmitter in the same power range.

There are other reasons why the MW-50 is superior. Like the use of only 5 tubes (in just 3 tube types) in the entire transmitter. And 130% positive modulation capability.

If you'd like to hear the whole story of the MW-50, write Gates Division, Harris-Intertype Corporation, Quincy, Illinois 62301.

**HARRIS**  
 **GATES DIVISION**  
Quincy Illinois 62301 U.S.A.

Circle 155 on Reader Service Card

"a complete monitoring system"

## FM • STEREO • SCA

SEE US AT  
NAB '73  
Booth 213

### TBM•3700 this is FM MONAURAL

- internal calibration
- measures internal S/N
- carrier failure indication
- full remote metering available



### TBM•2200 add this for FM STEREO

- simultaneous left/right reading of modulation
- metering function on one switch
- direct reading of separation and crosstalk

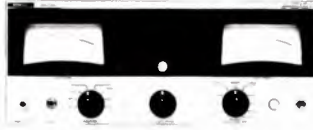

### TBM•2000B add this for SCA

- internal calibration of SCA injection
- frequency and modulation plug-in modular design
- **NEW for NAB/73**

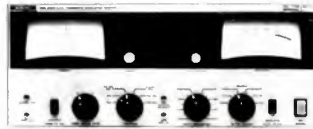

### TBM•2500C add this for OFF AIR monitoring

- excellent sensitivity
- superb selectivity
- 45 dB AGC range
- phase linear for excellent stereo/sca recovery



# monitors

For complete information, please contact: Director of Sales . . . . . (402) 342-2753

**M<sup>c</sup>Martin**

605 n. thirteenth street • omaha, nebr. 68102 • (402) • 342 • 2753 • telex 048 • 485  
Circle 156 on Reader Service Card

## BIG TIME NETWORK TV STAR.



**Tracor Model 600A Rubidium Frequency Standard. Used by NBC, ABC and CBS television networks. Price: \$7,700.**

Only rubidium standard found in TV application. Compact, rugged, designed for color subcarrier generation. Utilizes stable quartz crystal oscillator whose frequency is controlled by the atomic resonance in the ground state of rubidium 87. Features continuous rotation phase shifter and built-in Time Scale Selector. Long-term stability is  $3 \times 10^{-11}$ . Write or call for full technical and application information.

**Tracor**

Industrial Instruments

6500 Tracor Lane • Austin, Texas 78721 • AC 512/926-2800

Circle 157 on Reader Service Card

## PRODUCTS

cons, C23165D and C23165E, have greatly increased sensitivity from image intensifiers in the same envelope. C23244 BIVICON is a two gun tube, for simultaneous scanning of two images. The 4520 vidicon has an opaque frame mask, as an optical black reference. RCA. **301**

**Video motion detector** senses dark-to-light and light-to-dark changes over a video camera field. Model V220MD has a by-pass, a manual mode that stays off until reset, and an automatic mode that resets after six seconds following an alarm. Sensitivity setting uses a built-in null meter. VICON INDUSTRIES **302**

**New high-power stereo audio amplifier** includes redesign of output circuit for faster protection and better adjustment to reactive loads. Model DC-300A has power of not less than 150 watts/channel into 8 ohms, DC-20 KHz, at 0.05% IM distortion. Clipping point is 190 watts in 8 ohms, 340 watts into 4 ohms. Noise is 110 dB below 150 watts. \$685. CROWN INTERNATIONAL **303**

**Projector for Super 8 film with magnetic recording and playback capability** has a new horizontal, low-profile form, and extra-bright preview facility. Supermatic 70 uses instant loading film cassettes, has automatic and manual gain control for recording, mi-



crophone and phono recording inputs, automatic threading, pop-up projection screen, 18 and 24 f/p/s speeds, stop motion, instant review. \$550. EASTMAN KODAK. **304**

**New series of audio transformers** includes units matching 150, 600, or 3750 ohms to 150, 600, 15K, 30K or 60K ohms. MI Series have response  $\pm 1$  dB, 20 to 20,000 Hz, distortion below 0.2% at 20 or 30 Hz. Input power levels range from -30 dB to +30 dB. SESCO **305**

**New optional capstan servo** for Series AG-440 audio tape recorders provides continued on page 94



# FASTEST HANDLING SINGLE SYSTEM SOUND CAMERA IN THE WORLD.

Canon Sound Scoopic 200. A single system sound-on magnetic news documentary camera. Designed for the TV news cameraman. Without compromise. And with features long demanded . . .

**REFLEX VIEWING** through a 135° rotating mirror shutter. No beam splitter. **No loss of light at the film plane.**

**FULLY AUTOMATIC THRU-THE-LENS METERING** with manual override control. F stops visible in the viewfinder. Instant open and return diaphragm for fast focusing.

**FILTER SLOTTED** 12.5-75mm Canon zoom lens. Filter changeable in seconds.

**REGISTRATION PIN MOVEMENT.** Assures perfect framing.

**ELECTRONICALLY GOVERNED MOTOR.** Insures accurate sound speed.

**MODULAR TWIN SOUND HEADS.** Snap in and out in seconds.

**LIGHT WEIGHT.** 12 lbs. 6 oz. Including body with film chamber, lens, exposure system, sound heads and take-up spools.

**LOW PROFILE** bottom load design for 200 feet daylight spools. Shoot from cars, doorways . . . anywhere.

**AND MORE.** A 6 lb. 14 oz. over-the-shoulder amplifier/camera power pack in a single unit. With advanced automatic gain control with manual override. VU meter. Dual mike input. And a fast rechargeable battery that powers the camera, meter and amplifier through 2000 feet of film. Recharges in under 5 hours. Batteries interchangeable in seconds.

Feature for feature, Canon Sound Scoopic 200 adds up to getting the news faster than ever. See it in action at your Canon dealer. Or write us for more information.



**New New New**  
**Come out of the dark with great shots!**  
We've widened our rotating mirror shutter angle from 135° to 170° for more direct light to the film. And we've changed the lens opening from 2.5 to 1.8. Now you can shoot in much darker areas than ever before.  
At Canon we make good things even better.

**Canon**  
**SOUND SCOOPIC 200**  
Canon USA, Inc.  
10 Nevada Drive, Lake Success  
New York 11040

Circle 158 on Reader Service Card

[www.americanradiohistory.com](http://www.americanradiohistory.com)



## PRODUCTS

higher tape speed accuracy, lower flutter, better speed control, than standard drive. Precision servo replaces a hysteresis synchronous motor, has a crystal reference frequency isolating the DC servo motor from line frequency variations. Motor, tachometer, and drive capstan are all on the same shaft; tape speed accuracy is  $\pm 0.08\%$ . AMPLEX. **306**

**Low-noise capacitor microphone sys-**

tem is intended to complement Noise Eliminator system, has only 8 dB noise level. Model 3000 also works at high sound pressures, delivering + 20 dBm into 600 ohms at 110 to 140 dB sound pressure. Equalizer has four switched ranges; gain switch provides for close, medium or distant miking. BURVEN LABORATORIES **307**

**Tape reverberation unit** provides reverb signal with adjustable delay, 32 mS to 6.5 seconds, with two staggered playback heads on endless tape loop. Model S-1000 mixes delayed signal

with original, has tape speeds of 10, 20, and 40 ips, S/N of 46 dB, harmonic distortion 0.3% maximum, nominal operating level of + 8 VU. SPARTA ELECTRONIC CORP. **308**

**Data generator** delivers pulse patterns with a wide range of programmable and controllable parameters for test of digital equipment. Model DG-32C has 1 Hz to 10 MHz repetition rate, two fixed 16-bit channels, single bit or word repeat operation, can operate in continuous, single-word, or single-bit mode, has rise/fall time of 8 nanoseconds (typical). \$1975. QUESTECH. **309**

**Two-way line extender amplifiers** provide up to 26 channels forward, and reverse operation at 5-30 MHz. Model NOVA-LE 2W has full 25 dB gain at 300 MHz, 12 dB noise figure, cross modulation at -75 dB, second order beats at -72 dB. Plug-in equalizers provide 0-24 dB equalization range; return loss is 18 dB. Reverse filters work with 10 nanoseconds delay. AMECO. **310**

**Connectors for "fused disc" coaxial cable** claim 40 dB return loss or better, will not appreciably degrade low-loss



performance of cable on long runs. High-performance connectors comprise a full line, with all standard connector functions. EG&G, INC. **311**

**Automatic image enhancer** maintains picture sharpness without double enhancement on a pre-enhanced program. Model 875 has a comb filter

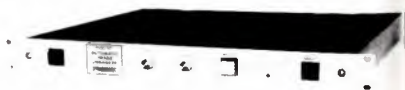

single-knob detail gain control, automatically balanced vertical and horizontal signals. Automatic operation can be disabled. DYNASCIENCES CORP. **312**

continued on page 95

# Matthey Video Delay Lines

Type M200-47001  
Delay range:  
5-155 ns, in 5 ns steps  
Equals:  
3 1/2 to 100 feet of coax cable  
Insertion Loss/Frequency:  
0.5 dB max. at 5.5 MHz  
Overall Attenuation:  
0.5 dB - not greater than 6  
Impedance:  
75 $\Omega$

Price	Quantity
\$25.00	1-10 units
17.00	11-49 units
16.25	50-Plus units

You can forget about whittling coax cable to correct phase and timing errors. Matthey video delays have better performance, are easier to install, don't change with temperature or humidity, and are less expensive than cable. They don't take up space: in one hand you can hold video delays equivalent to thousands of feet of coax cable.

Matthey fixed and variable video delays can be cascaded for a maximum delay of 4,000 ns. (2500 ft. of cable). Matthey video delays are available in PC modules, in metal boxes with BNC connectors, infinitely variable with switches and vernier, and rack-mounted. Try one without obligation.

Details from

Bill Pegler phone (516) 628-8068

**Television Equipment Associates**  
BOX 1301 BAYVILLE, N. Y. 11709

Circle 159 on Reader Service Card



# one in and ten out...

LPB's S-1 Audio Distribution Amplifier is perfect for simultaneously distributing your audio signal to transmitter, monitoring, recording and sound system circuits. Balanced 600-ohm input and outputs, with adjustable output levels up to +20 dBm. Metering on every output. Easily expandable with additional S-1's. The price is just \$345... only \$34.50 per output!

The S-1 Audio Distribution Amplifier is only one of our broadcast audio products. Call or write LPB for all your audio needs, from consoles to tape recorders.



LPB Inc.  
520 Lincoln Highway, Frazer, Pa. 19355 (215) 644-1123  
In Canada: P. O. Box 669, Orleans, Ontario (613) 824-3232

See us at NAB, Booth 540, Shoreham Hotel

Circle 160 on Reader Service Card



## ORGANIZATION & OPERATION OF BROADCAST STATIONS

By Jay Hoffer. Who does what, and how should it be done. In today's radio station? This new book answers these and scores of other perplexing questions by providing an in-depth examination of the job functions and responsibilities in modern radio—from manager to secretary, from announcer to salesman, from the traffic manager to the program director. Here for the first time in a systematic and professional presentation is a complete rundown on all the organizational and operational aspects of running a broadcast station! Proper application of the enormous amount of practical data in this new book will help to insure that the station operates as a team. 256 pps.

Order No. 533 Hardbound only \$12.95

## INTERPRETING FCC BROADCAST RULES & REGULATIONS—VOL. 2

By Editors BM/E Magazine. This series is indispensable for all broadcast personnel. Covers the legal requirements of broadcasting.

**PARTIAL CONTENTS:** Responsibility in Programming—Program Logs—Ascertainment of Community Needs—The Fairness Doctrine—Boundaries of "Obscene or Indecent" Language

Over-the-Air—The Lottery Station—Public Inspection of Network Affiliation Contracts, etc.  
Order No. 492 Comb-bound only \$6.95

## INTERPRETING FCC BROADCAST RULES & REGULATIONS—VOL. 3

**PARTIAL CONTENTS:** Comparative Criteria for Choosing Applicants—The Financial Showing—Fines and Forfeitures—Section 315 (Political Broadcast) Revisited—The "Personal Attack" Rules—Non-Communications Act Violators—Monitors for Stereo or SCA Operation—TV Multiple Ownership Rules—The FCC's

Position on Television CATV Cross Ownership—CATV Rules Reviewed—The Emergency Broadcast System.  
Order No. 603 Leatherette only \$6.95

## DESIGNING & MAINTAINING THE CATV & SMALL TV STUDIO

By Kenneth B. Knecht. A simplified, yet detailed guide on the installation and maintenance of production facilities for CATV, CCTV, ITV and broadcast TV studios. 256 pps., over 100 illus. 1972.

**CONTENTS:** Studio Pulse System—Switching Systems and Special Effects—Cameras & Lighting Equipment—The Film Chain—The Video Recorder—RF and Video Monitors—Video Terminal Equipment—The Audio Mixing Consoles—Audio Program Sources—Peripheral Audio and Other Equipment—Color—The Maintenance Shop—Distribution Systems—Putting It All Together—Designing Three Systems

Order No. 615 Hardbound \$12.95

## YOU'RE ON THE AIR!

By Sam Ewing. A practical do-it-yourself guide to a career in radio and TV for the student and beginning broadcaster. 224 pps., 1972.

**PARTIAL CONTENTS:** Preparing Yourself—Style is Your Stock in Trade—Broadcast Schools—Help Wanted, Everywhere—Happiness is Being Johnny-on-the-Spot—Air Breaks—A Commercial for Yourself—Broadcasting as a Business—"Powder Power"—The Sky's the Limit

Order No. 620 Hardbound \$7.95

## WHEN PIRATES RULED THE WAVES

Here's the complete story of the pop radio pirates who, for three years, operated unauthorized radio ships anchored off Britain's shores. For the first time, this book tells the full story of all the off shore radio stations—Radio Caroline, Radio London, and Radio Scotland, etc. The author describes how these stations grew and how they multiplied in number until competition among them reached—almost literally—the cut-throat level. The story is told of the dramatic events on the Radio City fort in the Thames, which culminated in the shooting of its owner. Interesting new light is shed on the often unscrupulous people involved in pirate radio, and on the far from glamorous life of a pirate disc jockey. The author tells how the pirate operations got started, how they were conducted (with numerous photographs) and how they were finally silenced. 216 pps., 13 Chapters and Appendixes. Hardbound.

Order No. 299 Only \$7.95

# Helpful Books that Belong in Every Station—Now on 10-Day FREE Trial!



## MODERN RADIO PROGRAMMING

By J. Raleigh Gaines, Program Manager KMYO, Little Rock, Ark., publisher of Ad Libber

**PREPUB  
SAVE \$2.00  
ONLY \$7.95**

A long-needed book on programming every type of modern radio station from progressive rock to classical music or all talk.

Everyone connected in any way with programming today's radio station, from general manager to program director and disc jockey, can add to his cache of knowledge and the performance of his function by thoroughly digesting the information contained in this idea-filled, up to date work.

Beginning with an evaluation and rating test, the author details the duties and responsibilities of a program director, that often maligned and frequently praised individual whose main concern is servicing management and keeping the station's programming within the confines of its design. An aspiring PD will quickly learn that his duties entail far more than making up the weekly playlist or DJ schedule. He'll learn why some fail and others succeed, and what is necessary to stay on top. The content

thoroughly covers music control and research, public service and community involvement, maintaining the quality of the "air sound," use of jingles and promotion, the various formats from contemporary to "block" programming, the multitude of programming components, how to determine a need and fill it into the program schedule, plus the importance and use of news, weather, sports, community service and other special features. Community involvement is a subject which receives extensive treatment.

Commercial and promotional creativity are vital to the very existence of a successful operation, and the author's treatment provides many suggestions to help you get the most out of available talent. Various commercial announcement approaches are described and illustrated to help you determine the best type to use for any situation. Of course, the disc jockey is the one who must "put it all together." 192 p.

Order No. 623 Hardbound Pre-pub. price \$7.95

## RADIO STATION SALES PROMOTIONS



By Jack Macdonald. 300 Merchandise Moving Ideas! A compendium of creative selling ideas designed exclusively for radio stations—sales tools that work. A vast supply of ready to use ideas for producing sales in 43 categories, from air conditioners to washing machines. BIG 8" x 11" size.

Order No. 214 Comb-bound \$10.00

## PLANNING THE LOCAL UHF TV STATION



by Patrick S. Finnegan, V-P & Ch. Eng. WLBC & WMUN. This brand-new guide describes all requirements for planning, building and operating a small, expandable UHF station. A valuable reference for station owners, managers and engineers containing practical data on eqpt., layout and economic factors involved. Includes many do-it-yourself hints and cost-cutting tips. 12 Chapters.

Order T-43 ..... only \$10.00



## THE BUSINESS OF RADIO BROADCASTING



### THE BUSINESS OF RADIO BROADCASTING

By Edd Routt, Assistant to the president, McLendon Stations; instructor in Station Management, Southern Methodist University.

Edd Routt has put together—in this one easy-to-understand handbook—all the magic, all the knowledge gained in 20 years of broadcasting...the complete details which lead to successful station operation based on the proven philosophies of the McLendon organization. It is destined to become the classic of the industry. Covers such problems as keeping up with and adhering to FCC regulations, dealing with labor unions, and handling personnel. Specific policies for stations in both major and minor markets are thoroughly explored. Job requirements at all levels are covered in great detail. The problems, hazards, accomplishments, and rewards of the business are candidly explained. The style of this long-awaited publication, although conversational and informal, teaches the terminology peculiar to the broadcasting industry. Actual case studies, taken from the author's own experience, and realism and practical guidance. 400 pages deal with hundreds of topics.

Order No. 587 Hardbound only \$12.95



## VIDEO TAPE PRODUCTION & COMMUNICATION TECHNIQUES



By Joel Efrein. A complete how to do it handbook on video production, direction, and program creation for broadcast, CATV, educational, and industrial applications. The author has taken a down to earth, how to do it approach to clearly explain every aspect of the subject. It is a practical text on techniques, with emphasis on production, beginning with the basics, the rudiments of putting a program together, and finally the direction of the complete undertaking. 256 pps., 125 illus.

Order No. 541 Hardbound only \$12.95

## ANATOMY OF LOCAL RADIO-TV COPY



By Wm. A. Peck. Guaranteed to be the most valuable thing a radio-TV writer can get his hands on next to a typewriter! This enlarged, updated 3rd edition of a real industry classic is loaded with hundreds of ways to increase station billing with sales-proven copy. Its purpose is to help you remove the "error" from the trial and error system. The techniques described have passed the most critical test to which advertising can be subjected...they sold the merchandise!

Order No. 90 ..... only \$5.95

## TELEVISION NEWS HANDBOOK



By David Dary. A complete guide to TV news department operation including how to gather, write, produce, and present TV news. Regardless of your status—working or would-be newsmen, station manager, or student, you will benefit from the behind the scenes insight incorporated into this work. For anyone now in radio news, this new book will provide a head start up the ladder. 256 pps.

Order No. 567 Hardbound only \$9.95

## HOW TO SELL RADIO ADVERTISING



By Si Willing. Millions of words have been written about salesmanship, yet thousands of salesmen are still groping for the right formula. And therein lies the secret as Si Willing illustrates it by theory and, even more important, by practice. You'll learn all the objections and how they've been successfully countered. You'll learn the approaches and

clinchers, how to use available sales tools to the best advantage, how to overcome fear and timidity, and how to deal with the competition. 320 pps.

Order No. 511 Hardbound only \$12.95

PLEASE TURN OVER FOR MORE GREAT BROADCAST BOOKS AND 10-DAY TRIAL COUPON



## GUIDELINES FOR NEWS REPORTERS

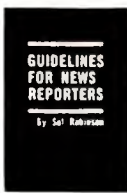

By Sol Robinson. In this invaluable handbook, the author relates quite specifically, and in great detail, the scores of practical techniques he has found to be successful. To be successful, the practicing newsmen must have the right answers—and he'll find them in this vital new work written by a thoroughly seasoned newsmen. Yes, here is a ready-to-

use guidebook, chock-full of practical help for both newsmen and announcers. The art of being absolutely accurate, fair and objective in reporting what actually happened is the job of a journalist, and the author tells how to maintain the necessary objectivity vital to the continuation of free news media. 192 pps.

Order No. 516 Hardbound only \$9.95

## POWER TECHNIQUE OF RADIO-TV COPYWRITING



By Neil Terrell. Based on a series of workshop seminars developed and conducted by the author for professional broadcasters. Teaches beginners, salesmen, and managers how to write broadcast copy that gets results, copy that will sell products and services. The author has drawn on his own skills as well as those of many other pros in presenting not only the how to information but

actual samples from the files of leading professionals. Tells how to use the proven Power Technique formula analyzing each account, determining the correct appeal and writing ad copy that will motivate people to buy. 224 pps.

Order No. 518 Hardbound only \$9.95

## AM/FM BROADCAST STATION PLANNING GUIDE



By Harry A. Etkin. A comprehensive guide to planning, building, and operating a radio broadcast facility—AM, FM, or combined operation. The author details how to find a frequency, apply for it, and how to plan and build a new station, or update and remodel an existing facility. Included are numerous floor plans, studio and transmitter

building construction guidelines, tower and equipment specifications, preventive maintenance—plus thorough treatments on preparation of Form 301 and making proof-of-performance measurements. 160 pps., 8 1/2" x 11".

Order No. 500 Leatherette \$12.95

## THE MAN BEHIND THE MIKE

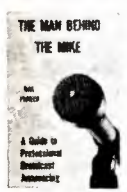

By Hal Fisher. This "Guide to Professional Broadcast Announcing" offers the practical help you need. Use of the down-to-earth pointers in this massive 288-page volume will help both seasoned and "green" announcers. Guidance on every phase of announcing. Contains over 40 drills to spark interest. Tells how to develop true professional talents,

how to become a good DJ or newscaster. 288 pps. Order No. 266 Hardbound only \$7.95

## RADIO PROGRAM IDEABOOK



By Hal Fisher. All the programing ideas you need to build and hold an audience. For the program director looking for a fresh source of ideas, this volume is loaded with suggestions to help him push his station's ratings to the top. For the ambitious announcer or DJ, this publication will help accelerate his progress. 10 BIG Chapters contain scores

of unique ways to give your audience a reason to listen. 256 pps.

Order No. 268 Hardbound only \$12.95

## PROMOTIONAL & ADVERTISING COPYWRITER'S HANDBOOK



By T.S. Ris. This work emphasizes the important aspects of preparing advertising or promotional copy for various media (newspapers, magazines, billboards, direct mail, radio, and television). It is essentially a copywriting course workbook which requires the student to complete some 18 different assignments. In so doing, the importance of copy style and

format are related directly to the job of creating and presenting the proper message. Also included are numerous worksheets. 128 pps.

Order No. 579 Vinyl Cover only \$7.95

## SPECIAL—FREE OFFER!

Order \$25.00 of books in this ad, send remittance with your order and we'll send you this fascinating book about broadcasting absolutely FREE! EDUCATION OF A BROADCASTER. Order No. 79 \$5.95

## HOW TO BECOME A RADIO DISC JOCKEY



By Hal Fisher. A comprehensive primer detailing the knowledge required of anyone seeking a career in radio broadcasting. Essentially a course in showmanship, this book teaches all the techniques needed to become a successful broadcast announcer (or disc jockey). The author, a professional broadcast consultant and instructor, herein

provides a virtual step by step guide to help the reader obtain his or her first job in a commercial radio station. Also ideal as a classroom text! 256 pps.

Order No. 557 Hardbound \$7.95

## RADIO NEWS HANDBOOK—2nd EDITION



By David Dary. This updated and revised handbook is written for both aspiring and experienced broadcast journalists. Serves as a day to day guide as well as a source of vital information for practicing newsmen endeavoring to improve their professional status. For the beginning newsmen, there is a solid grounding in radio news basics,

mechanics, and style plus necessary details on the workings of a radio newsroom. 192 pps., illus. Order No. 216 Hardbound only \$7.95

# HANDBOOK OF RADIO PUBLICITY & PROMOTION

Absolutely the World's Greatest Radio Promo Sourcebook!

- ★ A GIANT 372 page Handbook—a virtual promotion encyclopedia!
- ★ Over 250,000 words with all the promo ideas you'll ever need!
- ★ Over 1500 on air promo themes adaptable to any format!
- ★ Contains over 350 contests, stunts, station and personality promos!
- ★ Bound in handsome 3 ring binder!

BRAND-NEW and up-to-date—geared to TODAY'S radio needs! Here's the MUST book for stations wanting to attract more listeners, boost ratings, increase sales and profits. HANDBOOK OF RADIO PUBLICITY & PROMOTION contains just about all the sure-fire promotion and publicity ideas a radio station might ever need—hundreds of specific plans that can be profitably used by any station. One idea alone of the hundreds offered can be worth many times the small cost of this indispensable sourcebook.

Promotion is the keyword—the basic reason one station excels over another, all else being equal. Promotion is an important part—an integral part—of today's radio. Using the right approach you can give listeners a reason to tune in, a reason to keep listening, and at the same time make your station more salesworthy. True, few stations can afford a full-time staff of promotion experts, so here's the answer—a comprehensive handbook of hundreds of unique, exciting individual promotions, contests, stunts,

station and personality promos, etc. In each case, complete "nuts and bolts" details—how it works, copy details, prizes, sponsors, tie-ins—are included to enable you to adapt the idea to your own station format or sound. The author doesn't merely describe a promo or contest with a paragraph or two—he presents a synopsis of practical information, then provides complete instructions on how to plan it, sell it and program it.

Covering 9 basic categories, the all-encompassing, audience-building contents include contests, outside stunts, fun promotions, special station promotions, promotions for special days, weeks, and months (categorized month by month), station anniversary promotions, on air themes, plus general station and personality promos.

Additional Sections are a source of fresh new ideas, offering quickie humor material, station IDs, humorous show openers, and more. Order No. 213 only \$29.95

# Checklist of Objects Belong in Every Radio Station

## Audio & Hi-Fi—Stereo

- 4-CHANNEL STEREO—From Source to Sound. 176 pps. Hardbound \$12.95
- Selecting & Improving Your Hi-Fi System. 224 pps. Hardbound \$9.95
- Troubleshooting Solid-State Amplifiers. 256 pps. Hardbound \$9.95
- How to Build Solid-State Audio Circuits. 320 pps. Hardbound \$9.95
- Hi-Fi for the Enthusiast. 176 pps. Hardbound \$9.95
- Servicing Modern Hi-Fi Stereo Systems. 248 pps. Hardbound \$9.95
- Handbook of Magnetic Recording. 224 pps. Hardbound \$9.95
- Installing & Servicing Home Audio Systems. 256 pps. Hardbound \$9.95
- Audio Systems Handbook. 192 pps. Hardbound \$9.95
- Installing Hi-Fi Systems. 224 pps. Hardbound \$9.95
- Designing & Building Hi-Fi Furniture. 224 pps. Paperback \$9.95

## Computers

- Computer Technician's Handbook. 480 pps. Hardbound \$12.95
- Beginner's Guide to Computer Programming. 480 pps. Hardbound \$9.95
- Beginner's Guide to Computer Logic. 192 pps. Hardbound \$9.95
- Computer Circuits & How They Work. 192 pps. Hardbound \$9.95

## Reference Books

- Dictionary of Electronics. A handy reference to solve everyday needs. 420 pps., 487 illus. Hardbound \$9.95
- Handbook of Electronic Tables—2nd Ed. 224 pps. Hardbound \$9.95
- Electronics Data Handbook—2nd Ed. 256 pps. Hardbound \$9.95
- Basic Math Course for Electronics. 152 pps. Hardbound \$9.95

## Basic Electronics

- Basic Electricity & Beginning Electronics. 256 pps. Hardbound \$9.95
- Basic Color Television Course. 420 pps. Hardbound \$9.95
- Basic Electronics Course. 384 pps. Hardbound \$9.95
- Electronics Self-Taught: Experiments & Projects. 288 pps. Hardbound \$9.95
- How to Read Electronic Circuit Diagrams. 192 pps. Hardbound \$9.95

## Electronic Test Equipment

- Basic Electronic Test Procedures. 416 pps. Hardbound \$9.95
- How to Use Your VOM-VTVM & Oscilloscope. 192 pps. Hardbound \$9.95
- How to Test Almost Everything Electronic. 160 pps. Hardbound \$9.95
- How to Interpret TV Waveforms. 256 pps. Hardbound \$9.95
- 199 Test & Alignment Techniques. 224 pps. Hardbound \$9.95
- How to Use Vectorscopes & Oscilloscopes & SW Generators. 256 pps. Hardbound \$9.95
- Electronic Test & Measurement Handbook. 224 pps. Hardbound \$9.95

## Electronics Technology

- Introduction to Medical Electronics. 272 pps. Hardbound \$9.95
- Modern Radar—Theory, Operation and Maintenance. 160 pps. Hardbound \$9.95
- Marine Electronics Handbook. 224 pps. Hardbound \$9.95
- Digital Electronics: Principles & Practice. 288 pps. Hardbound \$9.95
- Industrial Electronics: Principles & Practice. 416 pps. Hardbound \$9.95
- Pulse & Switching Circuits. 256 pps. Hardbound \$9.95
- Working With Semiconductors. 224 pps. Hardbound \$9.95
- FET Applications Handbook—2nd Ed. 352 pps. Hardbound \$9.95
- Electronic Designer's Handbook—2nd Ed. 304 pps. Hardbound \$9.95
- Radio Control Manual—2nd Ed. 192 pps. Hardbound \$9.95
- Electronic Circuit Design Handbook—4th Ed. 416 pps., x 11. Hardbound \$9.95
- Handbook of Semiconductor Circuits. 448 pps. Hardbound \$9.95



# Helpful Books that TV Station Library

## Tape Recorders & Record Changers

- Practical Guide to Tape Recorder Repairs.** 256 pps. **Hardbound \$7.95**
- Home Recording for Fun & Profit.** 274 pps. **Hardbound \$7.95**
- Practicing Record Changers.** 224 pps. **Hardbound \$8.95**
- Elements of Tape Recorder Circuits.** 224 pps. **Hardbound \$7.95**

## Security Devices

- Installing & Servicing Electronic Protective Systems.** What you should know to start in business. 256 pps. **Hardbound \$7.95**
- Home & Theft Security Systems.** For home and business. 176 pps. **Hardbound \$7.95**

## Musical Instruments

- Electronic Musical Instruments.** From basic amplification to total electronic operation. 192 pps. **Hardbound \$7.95**
- Servicing Electronic Organs.** Covers most popular instruments in use today. 196 pps. 8 1/2 x 11. **Leatherette \$7.95**
- How to Repair Musical Instrument Amplifiers.** How to repair amps, guitars, organs, etc. 256 pps. **Hardbound \$8.95**

## FCC License Handbooks

- Commercial FCC License Handbook.** Covers 1st, 2nd, 3rd class plus Broadcast Endorsement. 432 pps. **Hardbound \$8.95**
- Commercial FCC License Q & A Guide.** Complete Q & A for all FCC exams. 288 pps. **Hardbound \$7.95**

## Communications Technology

- Amateur Band Radio Service Manual.** 228 pps. **Hardbound \$7.95**
- Radio Operator's Guide.** 224 pps. **Hardbound \$7.95**
- Radio Handbook.** Basic principles to construction. 320 pps. **Hardbound \$8.95**
- The Fascinating World of Radio Communications.** 176 pps. **Hardbound \$6.95**
- 2-Meter FM Handbook.** 312 pps. **Hardbound \$8.95**

## Amateur Radio License Guides

- Novice Class.** 180 pps. **Hardbound \$6.95**
- General Class.** 320 pps. **Hardbound \$8.95**
- Advanced Class.** 192 pps. **Hardbound \$7.95**
- Extra Class.** 224 pps. **Hardbound \$7.95**
- Technique.** 160 pps. **Hardbound \$6.95**

## General Servicing

- How to Repair Small Gasoline Engines.** 256 pps. **Hardbound \$8.95**
- Using Electronic Testers for Auto Tuneup.** 256 pps. **Hardbound \$7.95**
- How to Repair Home & Auto Air-Conditioners.** 208 pps. **Hardbound \$7.95**
- Small Appliance Repair Guide.** 224 pps. **Hardbound \$7.95**
- Refrigeration.** A diagnosis and repair guide. 160 pps. **Hardbound \$7.95**
- Frequency Changers: Rotating Type.** 100 pps. 8 1/2 x 11. **Paperback \$7.95**
- Automatic Control Basics.** 144 pps. 8 1/2 x 11. **Paperback \$9.95**
- Electric Motor Test & Repair.** 160 pps. **Leatherette \$6.95**
- Debugging Solid-State Electronic Power Supplies.** **Hardbound \$7.95**

## PROMOTION HANDBOOK

By Wm. A. Peck. A complete guide on ways to develop better ratings, and increase sales! It's a proven fact! Clever and well-planned promotion-campaigns lead to bigger audience ratings and greater sales! This brand-new publication is aimed at helping broadcast stations reap benefits of bigger and better promotional campaigns. Jam-packed with literally hundreds of ideas, and complete with scores of factual examples to show hot, new ways of promoting a station, this book no progressive station should be without. The author, drawing on many years of experience, tells how to make everything that happens at your station help to PROMOTE your station. Both on-air and off-air campaigns are covered. How to integrate on-air promotions with programming by means of contests, stunts, jokes, promotional announcements, streaks, etc. 256 pps., 5 1/2 x 8 1/2". **No. 267** **only \$9.95**

SAVE \$2.00 BY ORDERING NOW—PREPUBLICATION PRICE ONLY \$7.95

## HOW TO WRITE NEWS FOR BROADCAST & PRINT MEDIA

By David Dary, Professor of Journalism, Superior of Broadcast Journalism, William Allen White School of Journalism, Univ. of Kans.

"A very practical approach to the art of reporting and writing news." That's how Dr. Del Brinkman, associate professor of journalism at the William Allen White School of Journalism, University of Kansas, describes this compact course in the fascinating and challenging field of news reporting. It is written for the student, to guide him (or her) in the right direction. The practicing newsman, whether print or broadcast, will find this book of great value, because it explains how to handle all types of stories.

The concept of "news"—the meaning of the term and its nature—is thoroughly discussed. You'll learn what is news and what is not news by reading about the elements of and the classification of news. The reporter's qualifications are clearly defined, as well as the methods used to gather news. The author tells where news comes from and lists many sources

of local news. The author explains and illustrates what a "news beat" is, how to successfully conduct an interview, and how to get the most out of a "news conference."

The business of writing effective news stories receives much attention. The forms required for newspaper, radio, and television are illustrated and explained. Extensive detail is devoted to the syntax of the news sentence, the paragraph, and word selection.

For those interested in broadcast journalism, there's a chapter devoted exclusively to writing for radio and TV. It covers the basic techniques, and tells how to handle various story elements in a way that the listener will understand. Also included at the end of many chapters are self-help exercises to aid in developing your reportorial skills. 192 pps.

Order No. 643 Pre pub. price only \$7.95

A basic primer on journalism for the student or practicing newsman in both print and broadcast fields.

## GUIDE TO PROFESSIONAL RADIO & TV NEWSCASTING



By Robert C. Siller. A practical self-study guide for those who want to get started or get ahead in broadcast journalism.

**CONTENTS:** The World of Broadcast Journalism. Basic Equipment. Preparing for the Newscast. Writing for Broadcast. Making & Timing the Script. Use of Audio Tape. Television News. The TV Newscast. Elements of the TV Reporting Techniques. The Interview—Film & Video Tape Editing. The Completed Script—Anchoring the TV Newscast. A Career in Broadcast Journalism. 224 pps., 44 illus. **Order No. 535** **Hardbound \$9.95**

**Newscast—TV Reporting Techniques.** The Interview—Film & Video Tape Editing. The Completed Script—Anchoring the TV Newscast. A Career in Broadcast Journalism. 224 pps., 44 illus. **Order No. 535** **Hardbound \$9.95**

## BROADCAST STATION OPERATING GUIDE



By Sol Robinson. Here, in one handbook, are all the guidelines for station operation from starting a new facility to making a profit—from programming to accounting—one of those rare books which will prove valuable to both newcomers and oldtimers. It tells how to develop sound programming, what about editor

ializing, "payola," lotteries, network shows, political broadcasts, the Fairness Doctrine, etc. It delves into all types of market studies. 256 pages. **Order No. 467** **Hardbound only \$12.95**

## MODERN RADIO BROADCASTING

MODERN RADIO BROADCASTING

By R. H. Coddington. Here are the "real nuts and bolts" of modern radio operation, based on two decades of experience in all size markets, from the metropolitan gothals to the "peanut whistle" variety. No matter what your interest in broadcasting—management, production, engineering, etc.—you'll refer to this encyclopedic volume time and again. Provides an in-depth view of the largest single category of broadcasting station operation, the so-called "small" market.

**Order No. 482** **only \$12.95**

## TECHNICAL PAPERS PRESENTED AT NAB ENGINEERING CONFERENCES

These complete transcripts include the technical papers presented at the Conferences, plus the FCC Industry Panel discussion. Contains all the photos, slides and drawings presented in conjunction with the technical talks. Each BIG 8 1/2 x 11" size.

1967 NAB PROCEEDINGS, No. T-140	only \$10.00
1968 NAB PROCEEDINGS, No. T-148	only \$10.00
1969 NAB PROCEEDINGS, No. T-149	only \$10.00
1970 NAB PROCEEDINGS, No. 170	only \$10.00
1971 NAB PROCEEDINGS, No. 171	only \$10.00
1972 NAB PROCEEDINGS, No. 172	only \$10.00

## SPECIAL OFFER

SAVE \$5.05—Order Any 2 Volumes for \$14.95  
SAVE \$15.05—Order Any 4 Volumes for \$24.95  
SAVE \$27.05—Order All 6 Volumes for \$32.95

## MANAGING TODAY'S RADIO STATION

MANAGING TODAY'S RADIO STATION

By Jay Hoffer. A collection of critiques on the art, outlining principles evolved by the author during his 20 years as a broadcaster. Organized into three sections, the content encompasses management, programming, and sales. Part 1 considers two sides of a manager's environment—the personal and the impersonal—with comments on his many duties, from politics to personnel. Part 2 covers programming, primarily from the management viewpoint, although also of value to the program director and announcer. Part 3—Sales—offers help in finding and training salesmen, holding worthwhile sales meetings, setting rates, developing sales leads, etc. 288 pps. **Order No. 461** **Hardbound only \$12.95**

## NO-RISK 10-DAY FREE TRIAL COUPON

TAB BOOKS, Blue Ridge Summit, Pa. 17214

Please send me book(s) listed below

I enclose \$ \_\_\_\_\_

Please invoice on 10 day FREE trial

\_\_\_\_\_

Name \_\_\_\_\_ Phone \_\_\_\_\_

Station or Co. \_\_\_\_\_

Address \_\_\_\_\_

City \_\_\_\_\_ State \_\_\_\_\_

SAVE POSTAGE by remitting with order  
Foreign add 10% Pa. add 6% sales tax B-33

## CATV SYSTEM ENGINEERING—3rd EDITION

By Bill Rheinfeider. Here is the new 3rd edition of what has become the accepted technical standard of the CATV industry, an expanded and revised version of the first and only authoritative book on planning, designing, and operating a CATV plant. Contains answers to problems encountered almost daily in any system. 256 pps. **Order No. 298** **only \$12.95**

## CATV SYSTEM MANAGEMENT & OPERATION

By Robert B. Cooper, Jr. A complete guidebook to CATV—from locating new CATV situations, through acquiring a franchise, obtaining financing, opening and operating a system, budgeting, and buying and selling systems. While primarily non-technical in nature, this book covers the technical aspects for the owner manager. 256 pages. **Order No. T-100** **only \$12.95**

## CATV SYSTEM MAINTENANCE

The first and only book devoted to the maintenance of CATV systems. Includes adequate technical data on system design. Major emphasis is on maintenance—providing a wealth of information on how to locate and correct equipment failures, including tips on how to eliminate various types of interference and radiation problems at the head end. Step by step maintenance charts are included. 192 pages. **Order No. T-82** **only \$12.95**

## CATV OPERATOR'S HANDBOOK

Completely covers all aspects of the subject, from obtaining a franchise to financing and planning a new system, from installing a plant, promotion, selling hookups, to the very latest topics such as local program origination. Contains tested and proven information essential for practical day to day operations as well as for reference. 160 pages. **Order No. T-73** **only \$7.95**

SAVE \$11.85 ON CATV Combo  
All 4 books above, only \$34.95

Circle 161 on Reader Service Card



# WHERE ACCURACY COUNTS ... COUNT ON BELAR **AM FM TV**

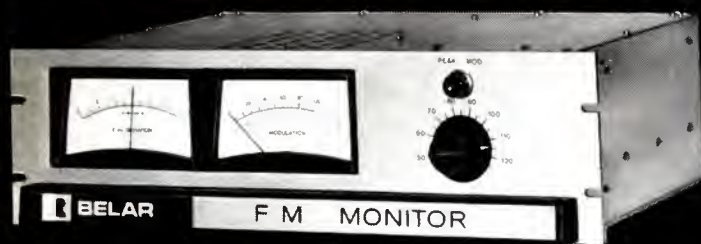

FM Monitor, FMM-1



Stereo Monitor, FMS-1



SCA Monitor, SCM-1



FM Amplifier, RFA-1

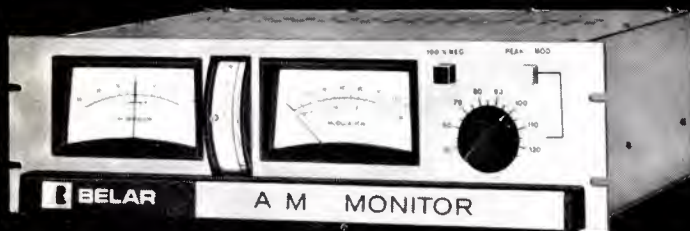

AM Monitor, AMM-1



TV Amplifier, RFA-3



TV Frequency Monitor, TVM-2,3



TV Monitor, TVM-1

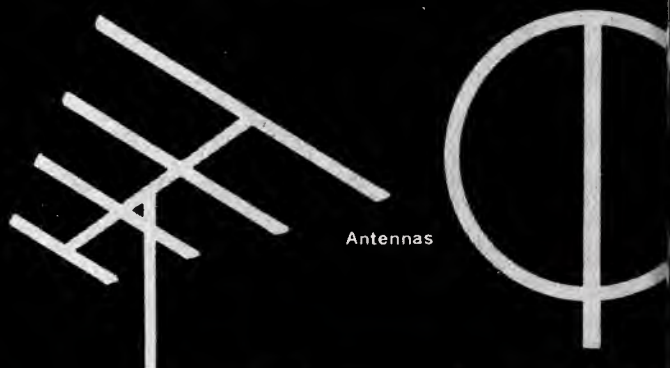

AM Amplifier, RFA-2

The secure feeling that you have purchased equipment that will accurately do the job you intended it to do is most comforting. When you buy Belar AM, FM, or TV frequency and modulation monitoring systems, you'll know that feeling. You'll know that you have the right equipment that will give you ease

of operation, functional checks and unquestionable ACCURACY. And you'll measure all your program material, including the peaks accurately.

Call or write today for more information. We know you'll make the right decision and BUY BELAR.



**BELAR ELECTRONICS LABORATORY, INC.**

LANCASTER AVENUE AT DORSET, DEVON, PA. 19333 • BOX 826 • (215) 687-5550

Where Accuracy Counts . . . Count on Belar

Circle 162 on Reader Service Card



## PRODUCTS

**High-power RF wattmeter** covers 25 to 500 MHz, from 1 watt full scale to 500 watts full scale, without changing plug-ins. Model 4372 has four switchable forward power levels, four reflected power levels (1-50 watts). VSWR is less than 1.1, accuracy  $\pm 5\%$ . \$500. BIRD ELECTRONIC. 313

**Frequency deviation counter** measures deviation from a pre-set nominal frequency to 1 ppm (.0001%) resolution, with a one-second computation time. Model B-9957 will also read out frequency in Hz, for frequencies down to 1 Hz, measure N-period total time in microseconds. BULOVA/AMERICAN TIME PRODUCTS. 314

**Solid-state lighting dimmers** are available in power ratings of 2, 3, 6, and 12 kW. "Astral" dimmers come in relay rack format, with the 2 kW model taking 1 $\frac{3}{4}$  inches of rack



space, weighing 7 pounds. Units have low noise, less than 35 dB, and rfi noise reduction, less than 10 quasi-peak micro-volts. SKIRPAN LIGHTING CONTROL. 315

**Frequency synthesizers** have 0.1 Hz resolution from 0.1 Hz to 13 MHz. Models 3330A and 3330B have push-button center-frequency setting, built in memory for programmed control of functions. Model 3330A has manual control of amplitude, 3330B has four-digit push-button amplitude control with 0.01 dB resolution over a 100 dB range. Solid-state digital displays show frequency and amplitude on the 3330B, frequency on the 3330A. Frequency stability is  $\pm 1 \times 10^{-8}$ /day, can be made higher with optional reference. Single or continuous sweeps are built-in. 3330A, \$5100; 3330B, \$6000. HEWLETT-PACKARD. 316

**Hardware and software for computerized logging, billing, accounting and traffic** are combined in package system. "Bat 1000" consists of a mini-computer with keyboard and CRT display, 8192-word memory, two cassette read-write transports, and a high-speed printer. System can communicate directly with any

ASCII code device. Installation is on a turnkey basis with operator training. System produces automatic log, plus all billing, payroll, statements, etc. INTERNATIONAL GOOD MUSIC, INC. 317

**Precision hysteresis synchronous motor** for direct replacement in Ampex and Scully audio units has direct capstan drive 3 $\frac{1}{4}$  and 7 $\frac{1}{2}$  ips, or 7 $\frac{1}{2}$  and 15 ips. Inside-out design cuts flutter and wow; electrified capstan cuts tape slippage

and wear. BEAU MOTOR DIVISION, UMC ELECTRONICS. 318

**Telephone answering unit can ask questions as well as record caller's voice.** The Ansafone 650 allows user to record any series of questions, with time between for the caller's answers. Questions are recorded on a tape cartridge; incoming messages on another tape. Incoming tape counter shows user volume of recorded messages when

continued on page 101

anticipating

# AUTOMATING?

Then anticipate Broadcast Products' complete line of flexible, low cost systems at

NAB, BOOTH 514  
SHOREHAM HOTEL

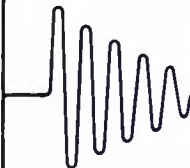

**BROADCAST PRODUCTS, INC.**  
660 LOFSTRAND LANE—ROCKVILLE, MD. 20850  
(301) 424-4700

Circle 163 on Reader Service Card

## Send only the best.

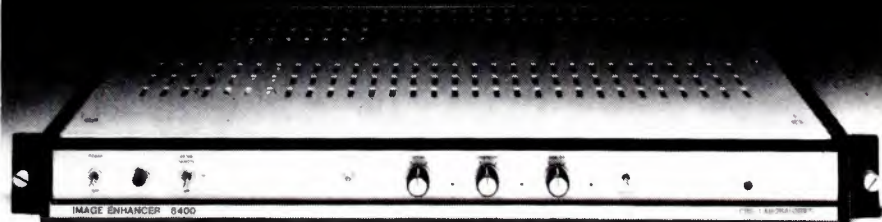

CBS Laboratories Mark III Image Enhancer is preferred by most TV stations. Because it sharpens both vertical and horizontal detail automatically. And improves picture resolution as well as color fidelity. The Mark III, with unique "crispended-comb" filter, separates chrominance from luminance, providing sharper contrasts with more defined picture detail. Available for all monochrome and color cameras. From CBS Laboratories, of course.

## CBS LABORATORIES

A Division of Columbia Broadcasting System, Inc.  
227 High Ridge Road, Stamford, Connecticut 06905

Circle 164 on Reader Service Card

# TREAT YOUR STUDIO TO THE BEST



**"THE PACKAGE"**



**MICRO-TRAK  
TONE ARM**



**6400-6401  
PRE-AMPS**



**206  
TONE ARM**



**2570 HEATER  
CONTROL**



**SERIES L  
FURNITURE**

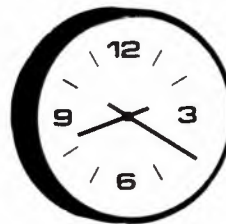

**CLOCK  
SYSTEMS**



**T LINE  
SPEAKERS**

## MICRO-TRAK CORPORATION

FORMERLY GRAY RESEARCH

620 RACE ST., HOLYOKE, MASSACHUSETTS 01040



## PRODUCTS

he returns. Unit can be set for 30-second answer limit, or can record continuously up to 30 minutes. **DICTAPHONE. 319**

**Field strength meter** for antenna installer has separate VHF and UHF tuners, covers 54 to 216 MHz and 470 to 890 MHz. Model FSM-4 reads signal strength in dBmV and in microvolts from 10 microvolts to 100,000 microvolts. Unit has audio output jack, gold-plated attenuator switches, 75-ohm, type F connectors. Battery operation and weight of about 4 pounds make it suitable for top-of-the-nast readings. **BLONDER-TONGUE LABORATORIES. 320**

**Slide projector kit** for time-message-weather channels in MATV and CATV uses a carousel slide projector, can handle up to 80 slides at one time. Model TMW-5SK works with Model FMW-5, sequences slides into message interval of the latter. Also needed is a heavy-duty projector (Kodak model 3-2 is recommended). \$465.00. **JEROLD ELECTRONICS CORP. 321**

**Portable spectrum analyzer for VHF** covers the range to 480 MHz in one band. Model 750 can sweep the whole band, and works down to 1 MHz with a double balanced mixer. A 500 MHz low-pass filter cuts spurious signals. The unit works up to 8 hours from battery pack; or an external 14 to 20 volts DC source can be used. **SYSTRON-DONNER. 322**

**Pinhole lenses for CCTV cameras** are designed for use where minimum exposure of front lens is wanted. Lenses have full optical correction—are not "fish-eye" designs—and come in focal lengths of 9mm and 14mm. Changes in aperture are made with separate Warehouse stops supplied as a set with each lens. **POWER-OPTICS, INC. 323**

**New popular-priced dynamic microphones** include two cardioid and one omnidirectional type. Model 1656 is cardioid, for broadcasting, recording, and general public address. Model 656G is for paging, cueing, or talkback. Model 1655 is omnidirectional, for outdoor interviews, news, and sportscasters. **UNIVERSITY SOUNDS. 324**

**Low-cost radio noise meter** operates on fixed frequency (either 834 KHz or 1000 KHz) in the broadcast spectrum. Model NM-21FFT requires no tuning, is easy for untrained personnel to use. Recorder output makes long-term  
continued on page 103

# RAPID-Q™ 3000

## CARTRIDGE TAPE EQUIPMENT

- RAPID-Q Adjustable Delayed Automatic Fast Forward Standard
- Modular Independent Units Single, Dual, or Triple Cases
- Rack or Desk Top Mount
- Superior Performance
- RECORD ■ PLAY ■ MONO ■ STEREO MODULAR UNITS



**RAPID-Q**

1216 KIFER ROAD SUNNYVALE, CALIF. 94086  
(408) 736-8737

Circle 167 on Reader Service Card

## our STATIONMASTER will keep you on the right track!

It will also handle your billing, keep your logs straight, give you sales reports or any of a dozen other things. It's at  
**NAB, BOOTH 514 • SHOREHAM HOTEL**

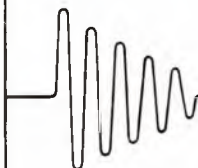

**BROADCAST PRODUCTS, INC.**  
660 LOFSTRAND LANE—ROCKVILLE, MD. 20850  
(301) 424-4700

Circle 166 on Reader Service Card

## Send only the best.



Only the best is good enough. And that's exactly what you get with CBS Laboratories power twins, Audimax and Volumax. Audimax delivers a distortion free signal by eliminating thumping, background "swish-up" and audio "holes." And Volumax prevents overmodulation and permits maximum per-watt coverage power. The power twins! From CBS Laboratories, of course.

## CBS LABORATORIES

A Division of Columbia Broadcasting System, Inc.  
227 High Ridge Road Stamford, Connecticut 06907

Circle 168 on Reader Service Card

## THOMSON-CSF VHF/UHF tubes and cavities:

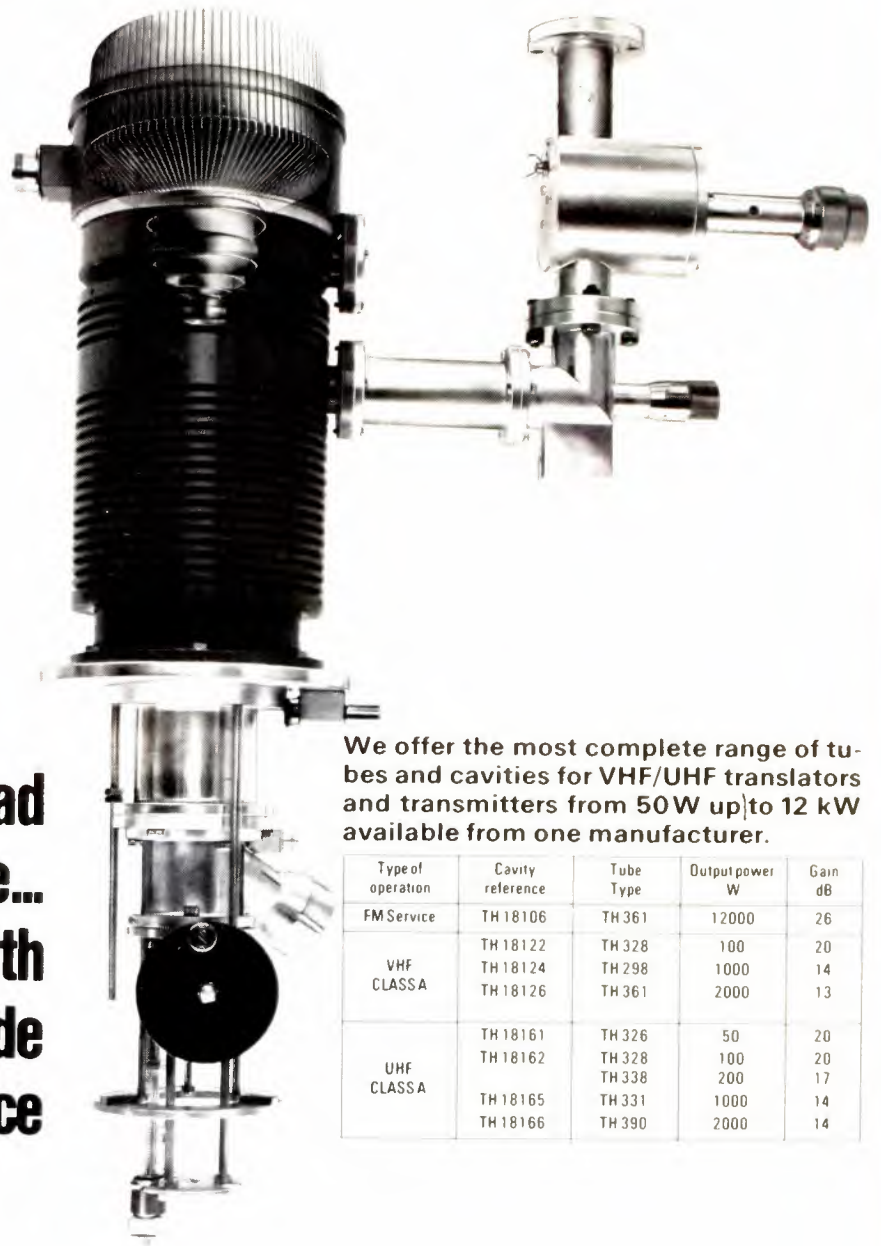

**years ahead  
in performance...  
backed up with  
over a decade  
of experience**

We offer the most complete range of tubes and cavities for VHF/UHF translators and transmitters from 50W up to 12 kW available from one manufacturer.

Type of operation	Cavity reference	Tube Type	Output power W	Gain dB
FM Service	TH 18106	TH 361	12000	26
VHF CLASS A	TH 18122	TH 328	100	20
	TH 18124	TH 298	1000	14
	TH 18126	TH 361	2000	13
UHF CLASS A	TH 18161	TH 326	50	20
	TH 18162	TH 328	100	20
		TH 338	200	17
	TH 18165	TH 331	1000	14
	TH 18166	TH 390	2000	14



**THOMSON-CSF**

THOMSON-CSF ELECTRON TUBES, INC / 50 ROCKEFELLER PLAZA / NEW YORK, N.Y. 10020 / TEL. (212) 489 0400

France - THOMSON-CSF Groupement Tubes Electroniques / 8, rue Chasseloup-Laubat / 75737 PARIS CEDEX 15 / Tel. 566 70 04

Germany - THOMSON-CSF Elektronenrohren GmbH / Am Leonhardsbrunn 10 / 6 FRANKFURT/MAN / Tel. 70 20 99

Italy - THOMSON-CSF Tubi Elettronici SRL / Viale degli Ammiragli 71 / ROMA / Tel. 638 14 58

Japan - THOMSON-CSF Japan K.K. / Kyosho Building / 1-9-3 Hirakawa-cho / Chiyoda-ku / TOKYO / 〒102 / Tel. (03) 264 6341

Sweden - THOMSON-CSF Elektronor AB / Box 27080 / S-10251 STOCKHOLM 27 / Tel. (08) 22 58 15

United Kingdom - THOMSON-CSF Electronic Tubes Ltd / Bilton House, Uxbridge Road, Ealing / LONDON W 5 2TT / Tel. (01) 579 1857 / Telex 25 659

1707



## PRODUCTS

ite monitoring feasible. SINGER INSTRUMENTATION. **325**

tridge storage racks come in modular units holding 25 type A cartridges vertically. WR-25 is unit; MRB-1 is mobile base which holds up to eight WR-25s carousel style; MR-200 is the combination of base and eight modules. WR-25, \$11.60; MRB-1, \$39.95; MR-200, \$132.80. FIDELIPAC. **326**

Waveguide bandpass filters have 0.2% to 10% bandwidths, handle power up to 20 kW. The BW Series are available with 2 to 8 sections, cover the frequency range 4 to 18 GHz. TEXSCAN CORP. **327**

Circular wave guide has attenuation of 0.9 dB/100 feet in the 5925 to 6425 MHz band (1.66" ID); and 1.4 dB/100 feet in the 10.7 to 11.7 GHz band (1.09 in. ID). Single and dual polarized transitions, mounting fixtures, are available. Isolation on dual transitions above 35 dB. Other frequencies, and dual frequencies, available. HARTECH INC. **328**

assette tapes have life-time guaran-

tee, lubricated stainless steel guide pins with rotating guide rollers. Series 261 comes in 40, 60, 90 and 120 minute sizes. \$1.80, \$1.85, \$2.90, and \$3.45. IRISH MAGNETIC TAPE. **329**

Portable digital multimeter has accuracy rated at 0.5%, 3 1/2 digit readout. Model 4442 is designed for field use, is protected against mechanical shock, has a self-contained rechargeable battery pack giving up to 12 hours continuous operation. There are

20 AC/DC voltage, current, and resistance ranges. \$425. WESTON INSTRUMENTS. **330**

Motorized pan and tilt drive for cameras has an auto scan feature. Model V3300API has clutch protected pan, hardened steel gear train, heavy duty roller bearings. Electrical connections to the tilt section are made through slip rings. It operates on low voltage, has mercury switch reversing. VICON INDUSTRIES, INC. **331**

## Loaded with Schafer value.



Schafer's new Model 102/010 professional tape recorder and reproducer provides excellence in craftsmanship and performance at an unbelievably low price. Value-packed features include:

- 3 speeds • Ferrite heads • Precision reel locks
- Hysteresis synchronous capacitor motor • Plug-in head assembly • Tape index counter

For details on the remarkable performance-to-price ratio of this new tape recorder, contact Schafer Electronics Corp., 75 Castilian Dr., Goleta, Ca 93017, (805) 968-0755. In Canada: Schafer Electronics Ltd., 584 Burbank Rd. SE, Calgary, Alberta, Can. T2H2Z, (403) 530351

**schafer** Electronics Corporation

Circle 170 on Reader Service Card

# ?

## YES, IT'S TRUE

Fairchild Sound invades the low-cost standard console field.

Everything you've wanted in inexpensive consoles, including extras available only from the custom technology of... Fairchild/Robins.

THE DEBUT: MARCH 25-28

BOOTH 309 • NAB '73

**FAIRCHILD** **ROBINS**

FAIRCHILD SOUND EQUIPMENT CORP.  
A ROBINS INDUSTRIES CORPORATION  
75 AUSTIN BLVD., COMMACK, N.Y. 11725  
CABLE: ROBINSOVERSEAS COMMACKNY  
(516) 543-5200

Circle 177 on Reader Service Card

MARCH, 1973—BM/E

## Send only the best.

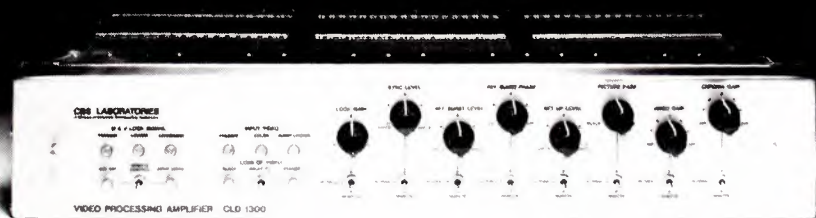

CBS Laboratories' new Video Processing Amplifier is an outstanding performer! For monochrome or composite color restructuring, CBS Laboratories CLD 1300 is the universal amplifier. High quality restoration is accomplished through individual controls of video, chroma, reference burst, sync and blanking.

In helical or quad tape use, the CLD 1300 actually improves quality dramatically. And the CLD 1300 can even be used simultaneously as a standby sync generator. From CBS Laboratories, of course.

## CBS LABORATORIES

A Division of Columbia Broadcasting System, Inc.  
227 High Ridge Road, Stamford, Connecticut 06905

Circle 171 on Reader Service Card

Variable-directivity  
condenser studio  
microphone provides  
130 dB dynamic range.



Dynamic range (130 dB)  
+ noise level (24 dB)  
= max. spl (154 dB)

Sony's variable-directivity (Omni-Uni) C-37P\* contains an advanced FET amplifier. A switchable attenuator is placed between the capsule and amplifier to prevent distortion even at extreme sound pressure levels.

The combination of proven excellence in sound quality, and the very latest in semiconductor technology makes the Sony C-37P indispensable in today's quality-oriented recording studio.

Also Consider:  
Studio standard condenser microphone model C-500.†

**SONY** SUPERSCOPE

\*Must be powered by Sony AC 148A or equivalent power source

†1972 Superscope, Inc., 8215 Vineland Ave., Sun Valley, Calif. 91352. Send for free literature.

Circle 172 on Reader Service Card

## NEW LIT

For copies of these literature offerings, circle number for appropriate items on Reader Service Card.

Sixteen-page brochure describes moderate-cost TV color camera, TK-630, which has three one-inch lead oxide pickup tubes, sealed prism optical system, detachable viewfinder. RCA. 200

All-electronic computer-controlled telex exchange, ELTEX II, is covered in six-page data booklet describing main operating features. Frederick Electronics. 201

Comprehensive line of panel meters and accessories, and a customized panel meter service, are fully described in a new 28-page catalog. Triplet. 202

Booklet covers detailed specifications and applications of sweep-frequency RF network analyzer for 400 KHz to 500 MHz, measuring impedance admittance, magnitude, phase and group delay, etc. General Radio. 203

Portable microwave radio for 1.7 to 15.25 GHz range is fully described in four-page brochure, showing separate transmitter and receiver modules, detailed specifications, and block diagrams of typical applications. Terra-Com. 204

Full data is available on specifications and use of endless-loop video cartridges, Model LV-5 (five minutes) and Model LV-10 (ten minutes), for many half-inch helican scan VTRs, in black-and-white and color. Sony. 205

Burn-in and electrical test sockets and carrier-contact systems for semiconductors are described in six-page brochure. K-Tech, Inc. 206

Bulletin details line of electronic counter/controllers, including totalizers and many controller options. De-Tec-Tronic Corp. 207

Wall chart shows appropriate Beyer microphone to choose for any of 22 general applications and 69 different musical instruments. Revox Corporation. 208

Log book for cable television systems includes ten forms suggested for keeping records of equipment performance, testing, and monitoring. "Equipment Record Log" has forms for antenna installation, antenna sig-

SHIVELY LABORATORIES  
ANNOUNCES A NEW GENERATION  
OF CIRCULARLY POLARIZED  
FM ANTENNAS



TYPE 6810 • 10 KW PER BAY



TYPE 6813 • 3 KW PER BAY



TYPE 6811 • 1 KW PER BAY



TYPE 6814 • 25 KW PER BAY

RADOMES OR DEICERS  
AVAILABLE FOR ALL MODELS

WRITE FOR INFORMATION ON  
ANTENNAS  
TRANSMISSION LINE  
FILTERS  
RF LOADS  
COAXIAL SWITCHES  
POWER COMBINERS



SHIVELY LABORATORIES,  
INC.

RAYMOND, MAINE 04071  
PHONE 207 655-3841

Circle 173 on Reader Service Card



# MAXI OUTPUT MINI BUDGET



Little Max, the compact color film processor that performs quality, small volume processing for a small amount of money. Little Max fits the bill without bankrupting whoever foots the bill. Using 8, 16 and/or 35mm film, Little Max automatically processes with CR-100 chemistry in 15 minutes dry-to-dry, as well as the standard ME-4 Process in 28 minutes. And when it comes to quality, Little Max can stand shoulder-to-shoulder with the big guys. Small size. Small price. Big value. Little Max.

That's me

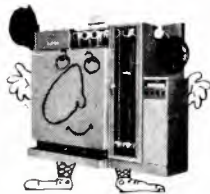

He's the  
Personality  
Processor

For further information call or write:  
Marketing Department,

**TECHNOLOGY INCORPORATED**  
HF PHOTO SYSTEMS DIVISION  
Div. of HOUSTON FEARLESS PRODUCTS  
11801 W. Olympic Blvd.,  
Los Angeles, Calif. 90064 (213) 272-4331

# LITTLE MAX

Circle 174 on Reader Service Card

## NEW LIT

nal measurements, headend tests, line amplifier records, and so on through entire system. Ameco. **209**

Bulletins on **pre-wired and connectorized jackfields** have photos, dimensional drawings and technical data, on units with Bantam jacks for two-wire, four-wire and six-wire telephone circuits. ADC Products. **210**

Full line of **microcircuit op amps** is covered in short-form catalog, "Linear Circuit Modules," which also includes sections on non-linear function modules and low-cost modular power supplies. Teledyne Philbrick. **211**

**Master antenna television system** gets detailed description in full-color brochure, showing application in hotels, motels, and hospitals, apartments, etc. RCA. **212**

Applications bulletin shows methods for making **low-resistance measurements** in the range from 0.001 ohm to 1 ohm, with accuracies of 0.06% or better, using four-terminal ratio capability of 3450A/B digital voltmeter. Hewlett-Packard. **213**

Illustrated 16-page brochure describes **CATV services, from feasibility studies to complete turnkey systems**. GTE Sylvania. **214**

**Low-light-level TV camera** that will produce usable picture with 5 X 10<sup>-5</sup> foot-candles (cloudy moonlit night) is described in new data sheet. Cohu Inc. **215**

**Expanded data service on electron tubes** and associated-components, called Data Service HB-3 DS, has replaced the earlier service, in use for 40 years; New service will consist of mailings of loose-leaf data booklets, full 8 3/8 in. X 10 7/8 in., with commercial, technical, and application notes. Domestic, \$8.50/year, foreign \$10/year, from RCA Commercial Engineering, Harrison, N. J. 07029. **216**

New 116-page catalog of **professional audio, broadcast, television, recording and motion picture equipment** is available. Audio Distributors, Inc. **217**

More than 235 books on **radio and TV servicing, audio and hi-fi, basic electronic technology, amateur radio**, etc., are listed in 72-page catalog. TAB Books. **219**

**News bulletin** issued periodically describes new technical and marketing **continued on page 107**

## Sony's award presenting microphone.\*

\*Used at Academy Award and  
Emmy Award TV  
presentations 1972



Featuring a high-performance condenser capsule of electret design, the ECM-53 is specifically designed for broadcast, recording studio, public address and similar applications.

The cardioid capsule assembly contains a permanently charged condenser capsule and FET/IC amplifier. A Cannon connector houses the battery supply.

- Frequency Response: (Frontal  $\pm 3$  dB): 40 Hz to 16 kHz
- Output Impedance (at 1 kHz  $\pm 20\%$ ): 50, 250, 600 ohms Balanced
- Maximum SPL (1 kHz): 134 dB

Also Consider:

Tie-tack/lapel condenser mic ECM-50.

Telescopic (from 7 3/4" to 17 1/2") condenser mic ECM-51.

**SONY SUPERSCOPE**

©1972 Superscope, Inc., 8215 Vineland Ave., Sun Valley, Calif. 91352. Send for free literature.

Circle 175 on Reader Service Card

# With your great ear, maybe you can get perfect sound sync. But can you really afford it?

Getting sound sync by ear is costing you a lot more than it has to. Because now you can get sound sync that's right on the money, instantly.

By using the SMPTE Edit Code and the new 3M Series 79 Synchronizer.

No more trial-and-error tape positioning, no "rocking and rolling," no time-wasting-tweaking of tape speeds until they sound right.

Just fast and easy sound sync, because with the edit code on your video and audio tapes, you've got split-second, absolute identification of the entire tape length.

For VTR editing, first transfer the sound track and edit code from your master tape (quad or slant track, monochrome or color) to any multitrack 3M Professional Audio Recorder.

Then manually park the tapes to within half a minute of each other using the Synchronizer's built-in edit code reader and start your VTR. The audio recorder automatically slaves to your VTR and locks into perfect sync, with no drift, no knob twisting no matter how long the tapes.

With this kind of precision, you can build a useable sound effects track by using the edit code for effect location. Get a high quality sound track by recording video and the code on your VTR, sound and the same edit code on a separate audio recorder. Build your own 24-track audio recorder by locking an



8-track and a 16-track unit together.

And, of course, your audio recorders should be 3M Series 79 Professional Audio Recorders. Mono through 24-track, they give you precise tape handling, extremely low

wow and flutter and signal-to-noise ratios that are state-of-the-art.

Used together, the 3M Series 79 Synchronizer and Professional Audio Recorders give you the sound quality and split-second accuracy you need for editing, dubbing and sweetening. Faster and at a much lower cost.

And what could be sweeter than that?

Professional Audio Products, 3M Company, 300 South Lewis Road, Camarillo, Calif. 93010. Telephone: (805) 482-1911. TWX: 910-336-1676.



**We've been there.  
And brought the answers back.**

**3M**  
COMPANY



# Where to get 3M's sound sync:



- Accurate Sound Corporation  
2702 National Circle Road  
Garland, Texas 75041
- Aengus Engineering, Inc.  
50 Oak Hill Road  
Fayville, Mass. 01745
- Audio Designs & Mfg. Inc.  
16005 Sturgeon  
Roseville, Mich. 48066
- Audio Recorders of Arizona  
3830 No. 7th St.  
Phoenix, Arizona 85014
- Automated Processes, Inc.  
80 Marcus Drive  
Melville, N.Y. 11746
- Fidelity Sound Company, Inc.  
GSA Dealer  
1200 18th St., N.W., Suite 105  
Washington, D.C. 20036
- Daniel Flickinger and Assoc.  
40 South Oviatt St.  
Hudson, Ohio 44236
- Gill Custom House, Inc.  
8813 W. 95th St.  
Palos Hills, Illinois 60465
- High Fidelity Showroom  
6383 Clayton Road  
Clayton, Missouri 63105
- Houston Electronics  
5709 Savoy Lane  
Houston, Texas 77036
- Jackson Sound Productions, Ltd.  
1403 So. Lipan  
Denver, Colorado 80223
- Martin Audio  
320 W. 46th St.  
New York, N.Y. 10036
- The Maze Corporation  
1900 First Ave. No.  
Irondale, Birmingham, Ala. 35210
- Milam Audio Corp.  
700 West Main St.  
South Pekin, Ill. 61564
- Pams, Inc.  
4141 Office Parkway  
Dallas, Texas 75204
- Sound Specialties  
2009 Naudain St.  
Philadelphia, Pa. 19146
- Telephase Electrosystems, Inc.  
595 Vandalia  
Memphis, Tenn. 38112
- Westlake Audio, Inc.  
6311 Wilshire Blvd.  
Los Angeles, Calif. 90048

## NEW LIT

events in cable and cctv fields applying to the supplier. Electronic Industrial Engineering, Inc. **222**

**Audio attenuators of a wide variety** together with comprehensive technical background and application notes, are shown in catalog, together with **variable filters and equalizers**. Shallco. **223**

**Oscilloscope with dc to 200 MHz optimum pulse response** is covered in complete technical brochure; unit has 8 X 10 cm display, 7 cm/ns speed, option for dc-to-250 MHz bandwidth, numerous other plug-in options. Tektronix. **224**

Bulletin on **Model TE-21 high-resolution closed circuit camera** describes use for image intensification, radiograph analysis, data transmission, film chains and others in which high resolution is needed. General Electric. **225**

"The Story of Computer Graphics" is a 12-page booklet describing in amusing style **man's attempts to communicate with graphics**, from the cave man to the present, and including detailed specifications on the **Model 7200A Graphic Plotter**. Hewlett-Packard. **226**

**Video digital clocks** are subject of new bulletin, showing use with inexpensive video monitors, single-conductor cable. Chrono-Log Corporation. **227**

**Comprehensive line of video instruments and processing units**, are covered in short-form catalog, including data display, analyzers, special effects generators, image enhancers, test and sync generators, TV-to-computer interfaces. Colorado Video Inc. **228**

**Step-by-step splicing procedure for Type TF totally-filled cables** are illustrated and described in a new comprehensive bulletin. Anaconda Wire and Cable. **229**

**Use of spectrum analysis in CATV performance measurement** is covered in great technical detail in 28-page booklet, "Spectrum Analysis and CATV Systems" which shows how nearly all parameters to be under FCC control can be determined. Tektronix. **230**

Bulletin describes use of "Strandwise" and "Strandlink" units for **anchoring and connecting cable strand, guy wires, etc.** with the proper tensions. Reliable Electric Company. **231**

# DYNAMIC!



**Model  
525**

## COMPRESSOR-LIMITER

- **Switchable Compression and Limiting functions**
- **Ceiling control for 20 dB of compression or limiting**
- **De-Ess switch (Anti Sibilance)**
- **Four selectable release time ranges**
- **Fast attack time**
- **Integral illuminated meter**
- **In-Out switch, Threshold and Output level controls**
- **Frequency dependent release times**
- **Low distortion, less than 0.5% 30 to 20,000 Hz**
- **Transformer coupled output to +24 dBm**
- **Stereo interconnection**
- **Utilizes Automated Processes 2520 Op Amps**
- **Panel mounting 1 1/2" x 5 1/4"**

Designed for individual channel use where quality, stability and ease of operation are of paramount importance, the extreme flexibility, repeatable performance and stereo interconnect features of the Model 525 make it extraordinarily suited for all studio applications.

The unique Ceiling control permits one knob control of compression or limiting in 2 dB steps over a 20 dB range while maintaining a constant output level.

The four Release Times, D-S feature, Mode of Operation and In-Out functions are controlled by positive action push button switches that can be rapidly operated.

Virtually all types of program material can be controlled with great consistency by the 525 without annoying side effects... **DYNAMICALLY!**



Circle 178 on Reader Service Card



## NEW BOOKS

**Technical Papers Presented at The 1972 NAB Engineering Conference** (TAB Book No. 172). 184 pages. Leatherette binding. \$10.00. TAB Books, Blue Ridge Summit, Penna.

This is a complete transcript of the papers presented at the NAB engineering conference held April 9-12, 1972. The transcript includes the original tabular and illustrative material—photos, diagrams—for each pa-

per. Strongly-reproduced, easily-readable type makes it a pleasure to use.

## Understanding Your Studio System

By Douglas Gratton

Once upon a time, one of my aunts heard that I was interested in television. At Christmas her present arrived—"The New Teach-Yourself Guide to the Basics of Television Engineering." The book was accompanied by a short note in which Auntie wrote that the nice man at the

bookstore had assured her that I was going to enjoy and understand this exciting book.

Well, the title—and her note—were the only two things that I understood in the entire book. The first sentence in the first paragraph began, "Hi! The importance of the crystal intersync lock on the non-composite video signal is often confused." And thus was my name added to the ranks of the unwashed, unbaptized, and confused.

Well, Kenneth Knecht may also have had an aunt who gave him that book for Christmas. If so, he has learned his lesson well. His recently published book, *Designing and Maintaining The CATV and Small TV Studio* (TAB Books #615, October 1972, \$12.95) is a model of quiet patient statement and explanation about the basic electronic principles of professional television studio design and maintenance. His emphasis is as a production engineer—he never even begins to discuss theory or CATV distribution.

His knowledge of his subject matter is as precise as his scope of the spectrum of engineering—and it is all summed up in the title. It is rare to find a cobbler who sticks to his last these days. Most of them seem to have diversified into shoe-shine stands, umbrella repairs and—for some unknown reasons—the selling of large florid stuffed animals.

Starting with the characteristics of the video signal and working up through cameras, VTRs, audio, monitors etc., Mr. Knecht concludes his book on systems philosophy and design. The back-index is helpful and concise with the listing of only major entries—though I suspect that this is for reasons of economy as much as for efficiency—and I especially found helpful the sub-index for each chapter.

I am not a professional engineer so I showed the book to one such animal and, apart from a few infrequent prima-donna sniffs, he pronounced it healthy in all respects. I am, however, a professional producer and such is the way of television that I believe that producers will benefit from understanding of basic engineering principles. How many CATV or ITV producers really know what to look for in the RETMA resolution chart (page 46)? So I shall keep this book on my shelf for my own reference and I commend that you do the same. **BM/E**

**Mr. Gratton** heads Gratton Associates Ltd., a New York production organization specializing in industrial and training films and tapes. He authors the *CM/E* series, "All You Ever Wanted To Know About Production."



# Spotmaster

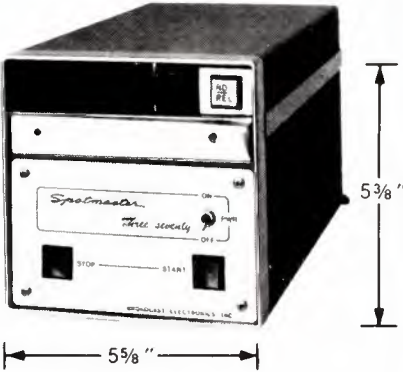

5 7/8"

5 7/8"

## Space Setter

### Three / 70 Cartridge Playback Deck

Meet our midget. And don't be fooled by its modest exterior. The new Spotmaster® Three/70 packs the performance of its big brother—the incomparable Ten/70—into a pint-sized package at a pint-sized price.

Standard features include the Ten/70's direct drive synchronous motor, all silicon solid state circuitry, high output (+8 dbm) and plug-in modular construction. Deck operation is pushbutton-quick, with instantaneous response.

Now look what happens when you put a trio of Three/70s together. They fit side by side in a single rack mount. The whole thing takes up just 7" of rack space.



Three/70s accept all Type A cartridges, playing up to 10½ minutes at 7½ ips. Options include 3¾ ips operation, as well as 150 Hz and 8 kHz secondary and tertiary cue tones (to augment the 1,000 Hz primary stop/re-cue tone).

Good things do come in small packages. Learn more about the Three/70—contact us today.

## BROADCAST ELECTRONICS, INC.

A Filmways Company

8810 Brookville Road, Silver Spring, Maryland 20910 • (301) 588-4983



**"Cartridges are our lifeblood. We have some of the most sophisticated cartridge-handling equipment in the country. We are converting to the Audiopak® Model A-2 cartridge exclusively."**

—Eric Small,  
Chief Engineer,  
WXLO 98.7  
stereo New York.



"We've tested other cartridges. A lot of other cartridges. Our tests showed no cartridge superior to the Audiopak A-2 in ruggedness, mechanical design, or (most important of all) consistency in phase stability."

"What you're looking at here is what we call the DTC. That's short for Disc Tape Cart Transfer system. It's as close to completely automatic cart making as the state of the art permits. Control logic is solid state."

"We make 50 to 150 carts a week. We've got to be able to rely on them. That's why we have standardized on the Audiopak A-2."

"Since all our music is on carts, they must be dependable. Without doubt, the A-2 gives us the reliability we need."

Shown here with Mr. Small is John Bailie, Maintenance Supervisor

**New Audiopak® A-2 Broadcast Cartridges**

Circle 179 on Reader Service Card

© 1970 Decca, Inc.  
Decca Industries Company  
150 West 21st Street  
New York, N.Y. 10011



# CROSS-TALK

Following are two requests for help that we wish we could respond to directly: we recommend them earnestly to any readers who may be in better position.

Editor, BM/E:

I am an electronics technician who six months ago succeeded in leaving Roumania and arriving in Israel . . .

Knowing the kindheartedness of Americans, I wonder if you could give me a helping hand: 1) I would like to take a refresher course, by correspondence, beginning with semiconductor devices through ICs to transmission equipment and techniques in mono and color TV, as well as microwave techniques. I do not know which institution is ready to send these courses to Israel; maybe you could let me have some addresses. 2) In your opinion, could I find an opening in the U.S. or Canada for a few years, to update my knowledge . . . I am 45 years old, possess the University

of Cambridge school certificate, the Roumanian matriculation, have (graduated?) in 1963 at the Electronics Technical School in Roumania. I speak English, French, German, Hungarian, Roumanian and elementary Hebrew. I have worked in electronics since 1959 . . . six years as maintenance technician of electronic equipment in . . . one of Bucharest's big hospitals.

Yours sincerely,

Amir Srasa, Givat Beik HaKeren,  
Block 1, entr. 3, apt. 23,  
Jerusalem, Israel.

Editor, BM/E:

I am writing to you for some advice concerning the possibility of obtaining studio broadcasting equipment for our inmate radio station.

In the early part of 1967 the C.C.I.S. Jaycees, an institutional chapter, with imagination for experience and what odds and ends that we could appropriate from the institution for parts, built a radio station. A local radio station gave us two well-used RCA turntables which, with some repairs, have given us very good service. Due to an increasing interest by my fellow inmates in the broadcasting field, we are looking into the idea of turning our closed circuit radio station into a broadcasting school which, hopefully, will teach the basics of this field and create a stronger interest, at the technical end, in an even greater future in the field of broadcasting.

If you could advise us as far as how to obtain used studio equipment, which we could repair ourselves if necessary, and printed material on the broadcasting field, your help would be deeply appreciated.

Sincerely yours,

Don J. Slater, Mgr.,  
C.C.I.S. Jaycees,  
Inmate Radio Station,  
Box 100, Somers, Conn.

Editor, BM/E:

Here is one for feedback that has been too long overlooked. I refer to the time printed on phonograph records. It is too small and about the smallest print on a record. It should be the largest.

The other day I ran across a record that didn't even have the time on it. The time should be very accurate and should be very large.

Ray G. Kelley  
Engineer, WLOH-AM  
Princeton, W. Va.

Correcting the record: High school stations are a long-standing and now continued on page 112

## two character generators for the price of one?



Absolutely—and only with the DATAVISION Model D-2400 Character Generator, performance-proven in worldwide broadcast use for:

- Title Inserts • News Flashes • Station ID's • Announcement Crawls • Video Production Work
- The D-2400 gives you two complete character generating capabilities for

the price of one. It's unique 2-channel output lets you display any one of 4 stored title pages on the "program" channel while you simultaneously compose or edit any other page on the "preview" channel. And, it lets you pre-compose program information on AUDIO TAPE for instant display.

Each D-2400 page displays 8 full rows of clear/highly visible characters. The characters are 32-scan lines high, and easily read as far as 30 feet away from a 21" TV screen.

That's not all—the D-2400 has plenty of other *Standard* features, too: 2-speed Horizontal Crawl, Controlled Word Flash, Handy Lower-Third Title Insertion which allows random access and display of up to 32 single-row titles, an easy-to-use Alpha numeric keyboard, Instant keyboard entry, Internal Non-additive Video mixing, and a Data Output Connector that really lets you talk with computers. Plus—a host of useful, optional features you can add to meet specialized requirements.

That's the DATAVISION D-2400. One character generator that does the work of two! Yours for only \$4,500. To learn more, or to arrange a free on-the-spot demonstration, just write or give us a call:

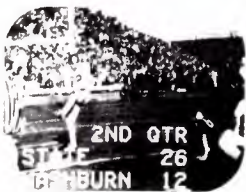

### MODEL D-2400

- \* COMPACT
- \* 4-PAGE STORAGE
- \* 2-CHANNEL
- \* 8 DISPLAY ROWS
- \* OPTIMUM SIZE CHARACTER

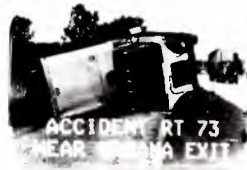

## DATAVISION, INC.

15932 Shady Grove Road  
Gaithersburg, Maryland 20760  
(301) 948-0460

Circle 180 on Reader Service Card



# ANOTHER GREAT TECHNICAL ADVANCE FROM GOTHAM.

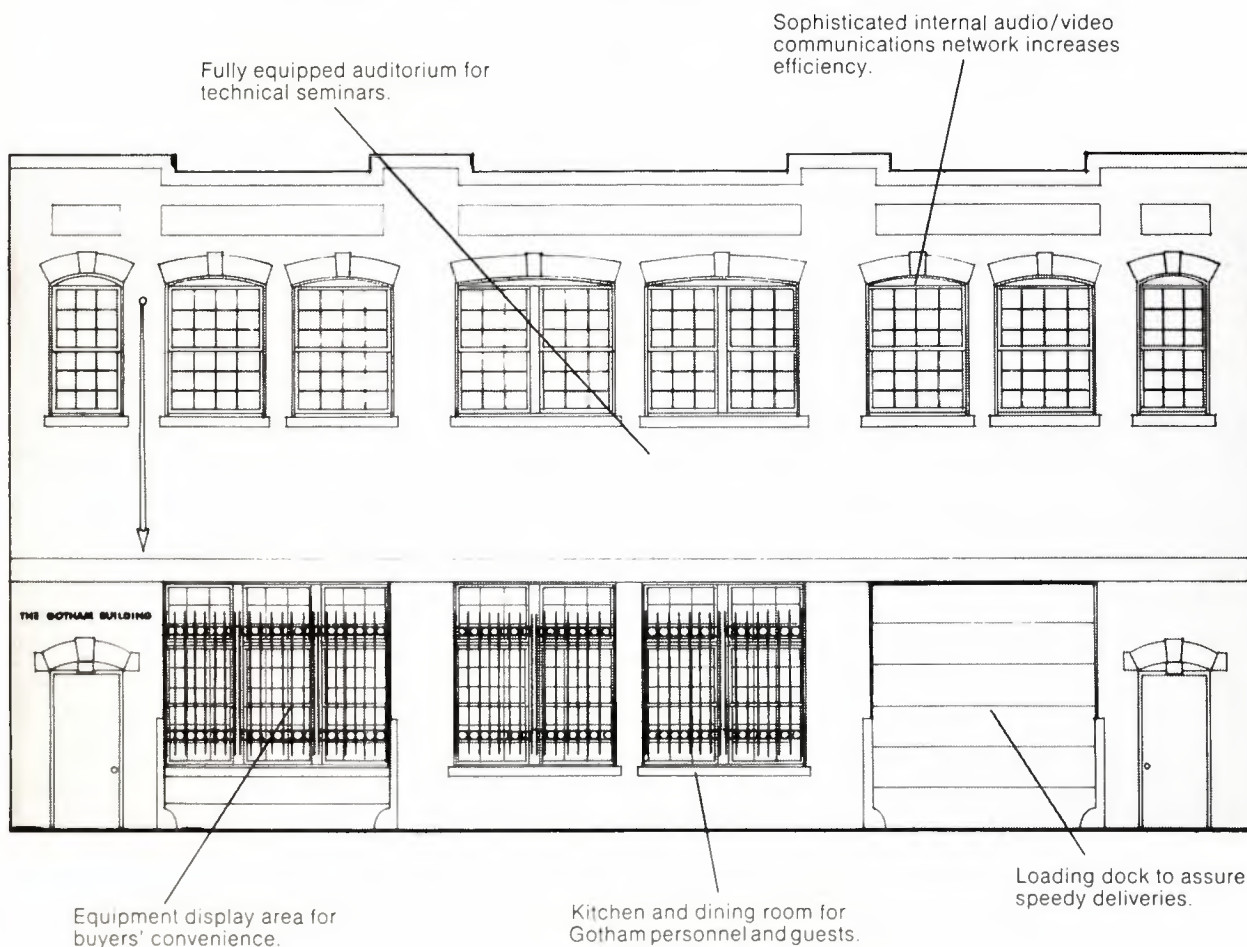

You're looking at an architect's drawing of the new Gotham Building at 741 Washington Street.

Located in downtown New York City, it took three years to design and build this ultra-modern installation.

Now it's ready. And you're cordially invited to visit us for a leisurely look-around.

It was you, after all, who made this new Gotham Building possible. You, and the manufacturers whose technological leadership has enabled us to offer the industry a steady flow of superb audio equipment for almost twenty years.

To all these companies—and to you—we dedicate our expanded facilities. And we look forward to many more years of providing you with mutually productive and rewarding service.

**GOTHAM**  
AUDIO CORPORATION

741 Washington Street, New York, NY 10014  
(212) 741-7411    Telex: 12-9269

Sales Office:  
1710 N. LaBrea Ave., Hollywood, CA 90046  
(213) 874-4444

## CROSSTALK

*rapidly growing segment of the broadcast community.*

We do know better, but we slipped anyway in a pre-publication rush. We failed to blue-pencil the claim, in a release concerning a 10-watt FM station just put on the air at Weaver High School, Hartford, Connecticut, that it was the "first high-school broadcast station."

The January issue was hardly in the mail before we began to get letters from other, often much older, high school broadcast stations. Finding out which was the very first high school broadcast station on the air will apparently take more digging in FCC files than we could manage before this issue went to press, but the date is certainly more than twenty years back. On the who-was-first question we are inclined to agree with Jon L. Busch, station manager of KSPN, Aspen, Colorado, when he says he

knows he is "inviting trouble" with his claim for KBPS, Benson Polytechnic High School in Portland, Oregon which according to Mr. Busch date to 1929!

Whoever started it, school stations mostly on low-power AM, were fairly scarce until the early fifties. Then the FCC's simplified rules for 10-watt FM educational stations began to stimulate school interest.

Today there are well over a hundred such stations licensed to local school districts. In addition, another kind of "broadcasting," the carrier current system, which does not require FCC licensing, has become important in the schools: LPB, Incorporated, a principal supplier in this field has sold systems to, or discussed them actively with, about a hundred schools. Applications in all the school categories went up sharply in the last two years, so the number of stations in service will before long be considerably above what it is now.

Typically, the high school station is staffed by students with one or two faculty directors. A good example is WIRQ, FM 10-watter at Irondequoit High School, Rochester, New York, one of our correspondents. The station is on a regular five-day week, usually eight to ten hours a day, with many music programs, literature, and art discussions keyed to high school interests, news specials, a platoon of student disc jockeys, school sports and other material tailored to the teen-age audience.

Another school makes intriguing use of its station: in driver training courses, a number of student drivers out on a large lot near the school, get individual instruction via the radio in each car, allowing one instructor to handle all of them at the same time (obviously the students have to be competent enough to avoid running each other down).

In many schools the student activity in the station counts as laboratory work in regular courses in broadcasting: announcing, station operation studio practice, etc. Such courses are spreading rapidly in high schools across the country.

We want to thank the following, who were the first to write us with information about school stations: Harrison J. Klein, consulting engineer of Boston, who told about WHSR, WJH, and WRSB, all in Massachusetts high schools; Bonnie Teklin, manager of WIRQ, mentioned above; Michael Muderick, of WTAJ-TV in Philadelphia, who told about WHES, Haver-town High School; and Meyer Gottesman, chief engineer of KYSM, Mankato, Minnesota, who reported on KUHS in Concord, California. **BM/E**

# AUTOMATION... NOT FRUSTRATION!

You'll never be frustrated, just Automated, with a Broadcast Products System —the flexible, low cost ones on display at  
**NAB, BOOTH 514 • SHOREHAM HOTEL**

**BROADCAST PRODUCTS, INC.**

660 LOFSTRAND LANE—ROCKVILLE, MD. 20850  
(301) 424-4700

Circle 182 on Reader Service Card

## Aristocart: less of what you don't want, more of what you do

- Less wow and flutter
- Less db loss in mono mix from stereo
- Less variation from cart to cart
- More consistent Phase relationship
- More head life—as much as double
- More tape life—less pressure, less wear

"We get consistent, clean sound from the fabulous Aristocart"—Wally Nelskog, KIXI, Seattle. "Tremendous improvement. Consistent cart to cart"—Tom Milner, KEZR(FM), Anaheim. "Only cart that's really satisfactory"—Paul Wieman, KKDJ, Los Angeles.



Introductory offer lets you convince yourself. Dealer inquiries invited

# IGM

Tomorrow's engineering today

3950 Home Road, Bellingham, Wash. 98225 • (206) 733-4567

Circle 183 on Reader Service Card



# AT NAB 73 BOOTH 207

IN THE SHERATON PARK HOTEL

SEE WHAT'S NEW FROM 

- AUTOMATIC TAPE EDITING
- BROADCAST AUTOMATION
- TRANSMITTER REMOTE CONTROL
- PRODUCTION SWITCHING
- MASTER CONTROL
- ENCODED CHROMA KEYING
- AUDIO CONSOLES

## automatic VTR editing system

a precision tool  
for creative people



Only the Central Dynamics PEC-102 offers all this:

- Computer control
- CRT readout with mimic display
- SMPTE time code
- Video production interface for complete effects control
- 600 scene mass storage file (optional)



**CENTRAL DYNAMICS LTD**

CANADA - 147 HYMUS BLVD., MONTREAL 730, QUE.  
U.S.A. - 230 LIVINGSTON ST., NORTHVALE, N.J. 07647

Circle 184 on Reader Service Card

**Business Briefs**

**Oak Industries** has formed a new group, **Oak CATV/Security**, to make and market products in those fields, with Carl J. Bradshaw as group vice president . . . **Theta-Com** announced receipt of patent No. 3,699,465 by John A. Pranke, manager of engineering, covering self-balancing push-pull amplifiers used in some Theta-Com systems . . . Some recent editorials, each

broadcast a number of times on **WCBS Radio**, N.Y., were on: tighter control of methadone for addicts; a school integration dispute in Canarsie, Brooklyn; a labor-leader comment on a city "productivity" drive; and support for a New Jersey bill guaranteeing reporters' rights to source secrecy.

**KRLN-TV**, public station in San Antonio, Texas, won a CPB Local Program Award for a bilingual series for children, "Carrascoldenas." . . . **Television Arts Inc.**, Columbia, S.C., is a new production and consulting firm serving TV and

cable with programming development, commercials, market analysis. Michael A. Fields is president . . . **WWPB-TV**, Maryland's third educational TV station, located in Hagerstown, goes on the air in late spring with about \$600,000 worth of **RCA** studio and transmitting equipment.

**WTCN-TV**, Metromedia station in Minneapolis, put in service in November its new 1375-foot antenna tower, 905 feet higher than the old one, for greatly improved service in the area.

continued on page 11

**It writes English  
without a  
COMPUTER ACCENT!**

It's Broadcast Products multi-language English Print-Out Logger . . . the one that's flexible, low cost and fluent in just about any language. At  
**NAB, BOOTH 514 • SHOREHAM HOTEL**



**BROADCAST PRODUCTS, INC.**  
660 LOFSTRAND LANE—ROCKVILLE, MD. 20850  
(301) 424-4700

Circle 185 on Reader Service Card

**THE  
LEADER  
IN  
CATV  
TOWERS**



*"Quality—Service  
and Price!"*

Yes, quality, service and price on CATV systems are the reasons for Fort Worth Tower's position as the industry's leading supplier. Experience gained as a pioneer supplier of CATV enables Fort Worth Tower to provide you with a quality product at a price that is reasonable and attractive.

Take advantage of our experience. For assistance in systems planning, engineering and complete systems quotations . . .

**CALL OR WRITE TODAY**  
***Fort Worth Tower***  
**COMPANY, INCORPORATED**  
P.O. Box 8597, Fort Worth, Texas  
(817) JE 6-5676  
—Associated Companies—  
Tommy Moore, Inc.  
Big State Engineering, Inc.  
Tower Construction Finance, Inc.

Circle 187 on Reader Service Card

**You Could Smile Too . . . IF YOUR HELICAL-SCAN VTR'S OUTPUT IS AS STEADY AS THIS DISPLAY. BUT YOU WON'T KNOW UNLESS YOU'RE CHECKING IT ON A LOW-COST UAP**



**PULSE CROSS MONITOR**

THE MODEL PC-95  
WITH UNDERSCAN  
AND AUDIO, TOO

REQUEST  
BULLETIN  
BM 373

AND TAKE A LOOK AT OUR BUDGET-PRICED WAVEFORM MONITOR



**Ultra Audio Products**

Box 921 Beverly Hills, Calif.  
90213 (213) 849-1433



Circle 186 on Reader Service Card



# Do wonders for your image

Whatever your CCTV requirement . . . or problem . . . we think you should think of Shibaden.

Shibaden offers a complete line of *professional quality* video equipment. Tested, proven and in use throughout the world.

Education. Training. Medical. Industry. Security. Broadcasting. Cablecasting. You name it . . . there's a Shibaden TV camera, video tape recorder, monitor or receiver, and all the accessories for it.

The video products pictured below are only four of the 150 currently available to those who won't compromise quality, yet must consider economy.

Look into the camera line. From mini-sized security cameras, up thru the high-

quality, moderate-priced black and white studio cameras (as the popular FP-100D shown below), and on up to the Shibaden FPC-1000s and the FP-1200, the professional color camera.

Check out Shibaden VTRs. The 510D with electronic editing is shown below. Their many features include (at no extra cost) variable slow and stop motion, servo capstan, internal sync and EIAJ-format specs.

And so on. Portable VTRs. Monitors from 5" to 23". Switcher/Faders. Special effects generators. Lenses. If you need it, you name it. Chances are Shibaden has it . . . off the shelf.

Write today for full specs and costs on one or all of our products. We may be able to do wonders for your image.



**SHIBADEN CORPORATION OF AMERICA**

Exec. Off.: 58-25 Brooklyn-Queens Exp'y, Woodside, N.Y. 11377  
21015-21023 S. Figueroa St., Carson, Calif. 90745  
1725 No. 33rd Ave., Melrose Park, Ill. 60160  
100 Martin Ross Ave., Downsview, Ontario, Canada

Circle 188 on Reader Service Card

[www.americanradiohistory.com](http://www.americanradiohistory.com)

# STOP GROUND-LOOP HUM!

VIDEO  
HUM STOP COIL  
HSC-1

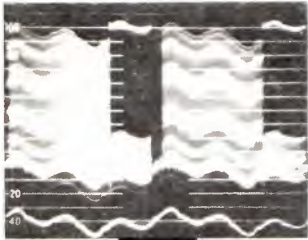

NEW!

NEW!

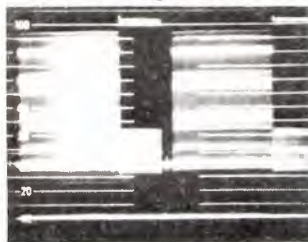

● Will **ELIMINATE HUM** and other **INTERFERENCE** in Video Lines caused by differences in Ground Potential!!

- For Color and Black & White
- FLAT — DC to 6.5 MHz
- No Low Freq. or Hi-Freq. Roll-off
- No Differential Phase Distortion
- No Differential Gain Distortion
- No Envelope Delay
- Reversible
- Passive Device — Failure Free
- Small Compact Package 4" x 4" x 2 1/4"
- Low Price.

**\$110.—F.O.B. NY**

### ELIMINATES HUM & INTERFERENCE:

- **IN FIELD**
  - Between Remote Truck & Telco
  - Between Remote Truck & Microwave
  - For Intertruck Hookup
  - For VTR Units
  - For Monitoring Lines
- **IN STUDIO**
  - Between Buildings
  - On long runs in Buildings
  - Between Studios & Transmitter
  - On incoming TELCO circuits
  - On Outgoing TELCO circuits

**AUDIO-VIDEO ENGINEERING COMPANY**  
65 Nancy Blvd., Merrick, N.Y. 11566  
Tel. (516) 546-4239

Please send Add'l. Inform. on HSC-1  
Please send me HSC-1 coil(s).  
Enclosed is remittance of .....  
Please Invoice on 10 day Free Trial

Name .....  
Station or Co. .... Title .....  
Address .....  
City ..... State ..... Zip .....

Circle 189 on Reader Service Card

## NEWS

**National Teleproductions Corp.**, Chicago, opened new, enlarged studios for their production of commercials, IDs, programming, and processing of film and tape . . . Twenty-third annual **Broadcast Industry Conference of California State University**, San Francisco, will take place there April 8-11, with a large slate of awards to TV and cable: data from Benjamin Draper, 1600 Holloway Avenue, San Francisco, Calif. 94132.

**Memorex Corp.** reported revenue of \$102,583,000 and net income of \$582,000 for the nine months ended September 30, 1972, which compares with a loss of \$5,276,000 in the 1971 period . . . **Federal Pacific Electric**, equipment manufacturer of Clifton, N.J., has formed an advisory council of electrical contractors from across the country to advise on design of products . . .

**Cleveland Outdoor Advertising** of Merced, Calif., has bought from Eller Outdoor Advertising the non-metropolitan segments of the latter's Bakersfield and Fresno ad structures.

**Burnham and Company, Inc.**, New York investment banking firm, has issued a report explaining the effects of the FCC restrictions on ownership of broadcasting stocks; for copies, 60 Broad St., New York 10004

**Television Microtime, Inc.** has signed an agreement, for distribution of professional television products, with **Harvey Radio's** Professional Audio-Video Division . . . **Eastman Kodak** will present a feature-length film based on the Hale classic, "The Man Without A Country," on ABC-TV April 24, 1973, with movie star Cliff Robertson in the title role. . . .



**Videorecord Corp.** has signed an agreement with Video Nursing of Evanston, Ill., to distribute the latter's video training and education programs for nurses . . . **Pat Jenks Associates**, instrument rep. has opened two maintenance/calibration centers, one in Wakefield, Mass., one in Hamden, Conn.

continued on page 118

# QRK "FUTURA" CONSOLES



	MONO	STEREO
6 CHANNEL	\$1095	\$1695
10 CHANNEL	\$1995	\$2495
6 CHANNEL PREWIRED SYSTEM	\$2095	\$3145

## QRK

**EAST**  
716 JERSEY AVENUE  
GLOUCESTER CITY, N. J. 08030  
PHONE: (609) 456-1716

**WEST**  
1568 NORTH SIERRA VISTA  
FRESNO, CALIF. 93703  
PHONE: (209) 251-3008

A subsidiary of  
**CCA ELECTRONICS CORP.**

Circle 193 on Reader Service Card

# QRK CARTRIDGE EQUIPMENT



	PLAYBACK	R/P
MONO	\$495	\$695
STEREO	\$725	\$995

- DIRECT DRIVE
- BUILT IN 150 Hz TONE
- COMPACT—ONLY 5 3/4" WIDE
- UNEXCELLED SPECIFICATIONS

## QRK

**EAST**  
716 JERSEY AVENUE  
GLOUCESTER CITY, N. J. 08030  
PHONE: (609) 456-1716

**WEST**  
1568 NORTH SIERRA VISTA  
FRESNO, CALIF. 93703  
PHONE: (209) 251-3008

A subsidiary of  
**CCA ELECTRONICS CORP.**

Circle 190 on Reader Service Card





# MAGNETIC SOUND on FILM INTERLOCKED WITH TELECINE PROJECTOR

FOR 16MM — 17½MM — 35MM FILM  
IN ALL STANDARD TRACK CONFIGURATIONS  
SMPTE AND/OR CCIR EQUALIZATION  
INTERLOCK KITS AVAILABLE FOR ALL 16MM OR 35MM TV PROJECTORS

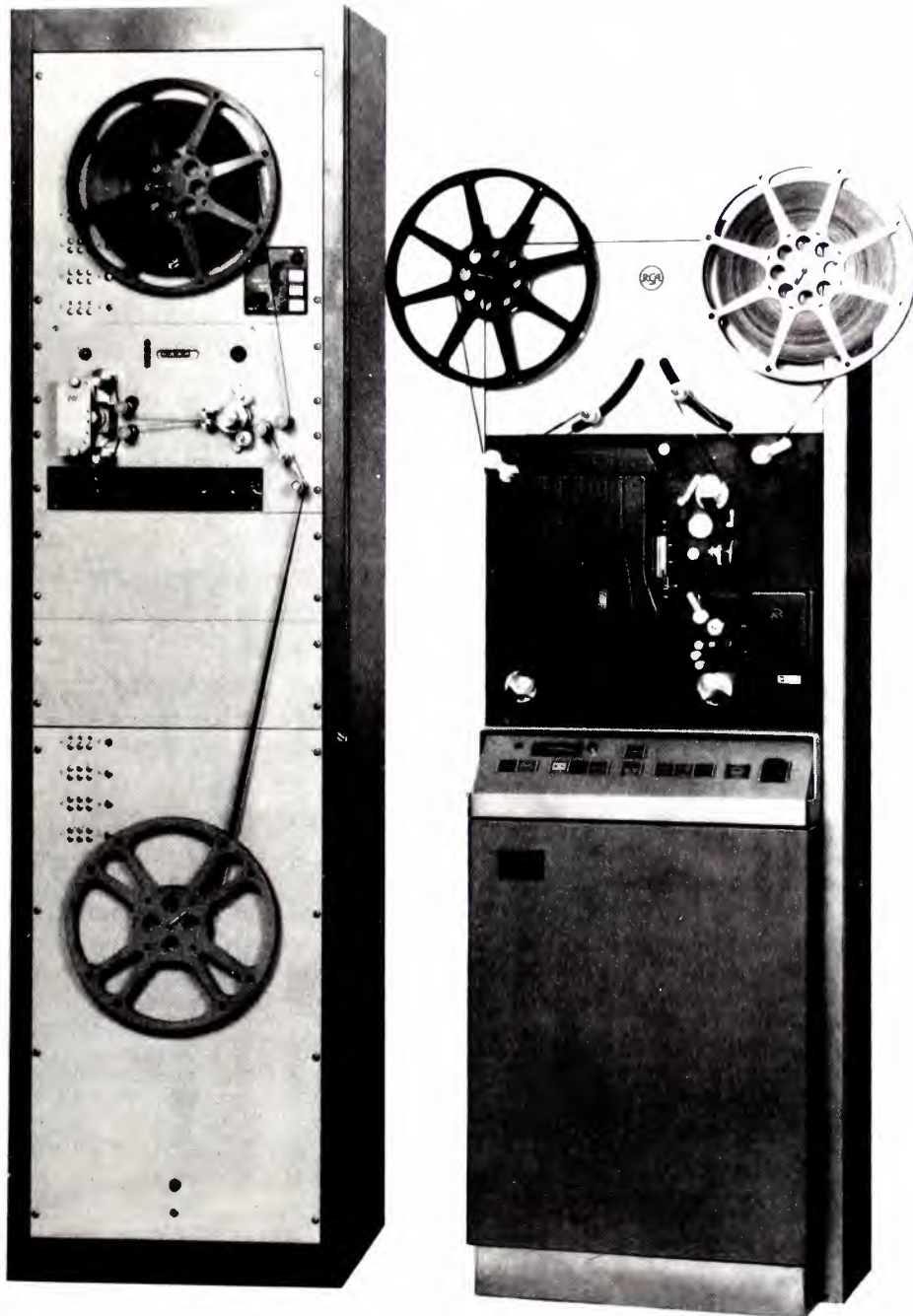

**MAGNA-TECH ELECTRONIC CO., INC.**  
630 Ninth Avenue / New York, N.Y. 10036

- Quad Eight - Magna Tech, 11810 Vose St., North Hollywood, Ca. 91605
- Cinesound International, Ltd., Imperial Studios, Maxwell Road, Borehamwood, England
- Magna-Techtronics (Aust) Pty., Ltd., 49 Whiting St., Artarmon, N.S.W., Australia 2064

Circle 191 on Reader Service Card

**Western Digital Corp.** reported loss of \$482,537 for six months ended December 31, 1972, compared with loss of \$640,099 for 1971 period; the break-even point for monthly operations was reached during the second quarter . . . **Sola Basic Industries** showed earnings for nine months ended December 31, 1972 of \$3,567,089, against \$2,660,446 in 1971 . . . **Association of Maximum Service Telecasters** will hold the annual membership meeting at 2 p.m. March 25 at the Shoreham Hotel, Washington; a special meeting of the Board of Directors is set for 2 p.m. March 24, and the regular board meeting will follow the membership meeting on March 25. **Citizens' Financial Corp.** of Cleveland will buy Northeast Data Com, Inc. from the New Haven Savings Bank. **WRTV**, Indianapolis, entered three of the four top award winners in the Television Bureau of Advertising's local commercial competition.

**Animation Filmmakers Corp.**, Hollywood, is making an animated TV series based on the Charley Weaver "Letters to Mama;" the

series will be called "Charley Weaver's Tales of Mount Idy" . . . **RCA** has sold to **Martin Marietta** more than \$1 million of COS/MOS integrated circuits for use in pocket paging units being made by Martin.

**Station WLOL Radio**, Minneapolis, won a Golden Mike Award from the American Legion Auxiliary, for the best program dealing with youth in 1972—"WLOL Focus—Youth" . . . **Electronic Homes Company** is a new firm formed by George T. Saddler, formerly marketing manager for TDK Electronics Corp.; the firm will manufacture and sell a full line of blank cassettes and open-reel tapes . . . **GBC CCTV Corp.** reported sales of \$4,386,003, and net income of \$165,889 for the year ended May 31, 1972, up from \$155,566 in 1971.

First **RCA** videotape cartridge system in Europe was installed by London Weekend TV, Ltd. . . . **Magnasync/Moviola Corp.**, subsidiary of Craig Corp., introduced the Moviola M-79 Junior, compact editing system; and opened a new Hollywood office (1001 N. Highland Avenue) for sales, rental and repair of the firm's movie products.

**Times Wire and Cable**, Meriden,

Conn., has agreed with LaSeneffoisse SA, a Belgian wire and cable producer, on a plan for a joint venture organization to make and distribute CATV cable in Belgium and other Common Market countries . . . **Reeves Cinetel**, New York, is the mixer for the Public Broadcasting series, "An American Family," the TV presentation of a real family's daily routine over several months . . . **Electronic Industries Association** estimated that the U.S. electronics industry had revenues of \$29.8 billion in 1972, up from \$27.9 billion in 1971—a 7% increase—with communications and industrial electronics up about 10%, consumer electronics up about 8%.

**Laird Telemedia** will supply film projectors and optical multiplexers as part of the production of \$1.8 million worth of video and film systems sold to the U.S. Navy by **International Video Corp.** for "Site" (Shipboard Information, Training and Entertainment), which will allow crews to see films and videotapes on shipboard . . . **Kaman Sciences Corporation**, Colorado Springs, has bought assets of Broadcast Computer Services of Webster,

continued on page 120

*1969 — World Video Introduces the First One-Gun Color Monitor . . .*

*1972 — World Video Introduces "The Un-Monitor"  
The Revolutionary 17" One-Gun Color Monitor . . .*

See the latest in professional color video monitors from "The Innovators" at the NAB Convention March 25-28, Booth 508 Shoreham Hotel.



CR6210



CR6700



CB6210



**WORLD VIDEO, INC.**

P O BOX 117 BOYERTOWN, PA. 19512

PHONE 215-367-6055





Irwin Ungerleider  
New York



Jack Keyes  
New York



Pete Stuart  
Los Angeles

## SELECT THE RIGHT TV LENS!

Our staff, headed by these men, is at your service.

Selecting the right television lens to do the best job is never easy. Many factors are always present to be reviewed and considered. These men can help you. Their experience and knowledge of the use of fine optics in television broadcasting and production, educational and industrial television and closed circuit television is invaluable. Let them assist you in reviewing your requirements and helping determine your needs. They will show by on-the-spot demonstration the right

television lenses that will do the best and most economical job.

Whether your immediate requirements are for a major broadcast studio or a surveillance installation system via closed circuit, call on this team to assist you. The tradition of excellence of Taylor Hobson Optics has been a hallmark for more than 80 years. These men will share this heritage with you to truly help you choose the right television lens. They are only a telephone call away, call them today.



Nick Glade  
New York

**SERVICE IS VITAL** - especially if problems arise when tight broadcast and production schedules must be met. Our technical staff is trained to respond to any problem - and give that expert care that fine optics require. When unforeseen problems arise, contact our service technician at the office nearest you for prompt, efficient assistance.



Don Henyan  
Los Angeles

VISIT OUR BOOTH 525 AT N.A.B. (SHOREHAM HOTEL)



### RANK PRECISION INDUSTRIES, INC.

New York	260 N. Rt. 303 West Nyack, N.Y.	10994 (914) 358-4450
Illinois	411 Jarvis Ave., Des Plaines, Ill.	60018 (312) 297-7720
California	5437 E. Sheila St., Los Angeles, Calif.	90040 (213) 722-3221

Circle 196 on Reader Service Card

N.Y., and will take over the marketing of the computerized traffic and accounting systems of BCS.

People

**Richard E. Putman** is director of engineering, Audio-Video Systems



Division, Philips Broadcast Equipment Corp. . . . **Joseph C. Groth, Jr.** won promotion to the presidency of TelePrompTer Manhattan CATV; he had been general manager for the preceding five years. . .

**Robert B. Hansen**, formerly manager of engineering, color TV, for Motorola, has joined Zenith Radio Corp. as director of color TV engineering. . . . **Edward S. Ely** was named chief engineer of KSan-FM, Metromedia stereo station in San Francisco . . . **John J. Sie** became



director of engineering of Acoustic Research, Inc.

**Marianne Faulkner**, business manager of WXIX-TV, Cincinnati, was named national chairman of the Management Development Committee of American Women in Radio and Television . . . **Eugene L. Bidun** became sales manager for LPB, Inc., makers of broadcast control-room equipment . . . **Jay B. Sondheim** was appointed general manager of KBHK-TV, Kaiser UHF station in San Francisco.

**Robert W. Flanders** was promoted to the position of vice president and director of engineering of McGraw-Hill Broadcasting. **BM/E**



division manager, terminal products and services division, of Jerrold Electronics Corporation.

**Richard W. Bock** was appointed midwest sales manager of Miratel Division, Ball Brothers Research Corp. . . . **John J. Bubbers**, who was vice president of field engineering for Stanton Magnetics, became

*Where can you get this quality and all these features — at this price?*

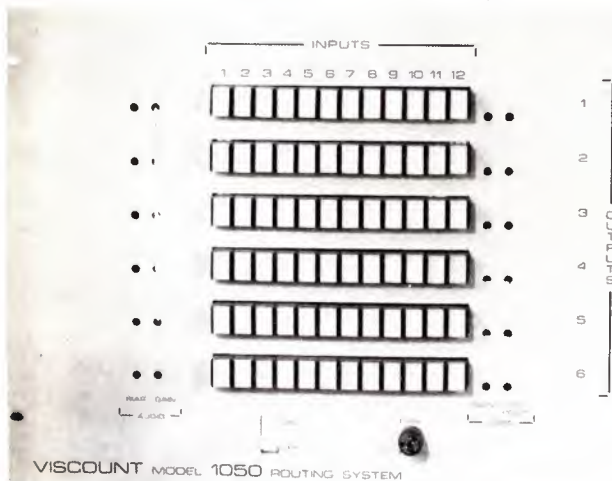

All VISCOUNT routers feature solid state circuitry throughout; colour compatibility to broadcast standards; illuminated push-buttons; any number of outputs from 1 upwards.

The 1050 has mechanical push-buttons and quasi-electronic cross-points, giving patch-panel prices with much improved performance. Recommended user price as illustrated: Video only \$2190; Audio only \$2080; Audio follow Video \$2770.

The 1035 has mechanical push-buttons and electronic video switching. S/N 60 dB to 10 MHz, EXT input also provides input for re-entry for up to 24 inputs. Expandable after installation. Recommended user price as illustrated. Video only \$2865; Audio follow Video \$3478.

Also available 1030 series all solid state routing switcher; X-Y address remote control head; touch-button control; 10 input x 10 output; 500 nsec switching time. Recommended user price Video only \$5700; Audio follow Video \$8500. Can be expanded after installation. Options include touchdial or thumbwheel control, or computer language address, also multiple switching memory.

DELIVERY 4 TO 6 WEEKS



**VISCOUNT VIDEO SYSTEMS LTD.**,  
Marine Industrial Centre  
105 East 69th Avenue  
Vancouver 15, British Columbia, Canada  
Phone: (604) 327-9446 Telex: 04-508605

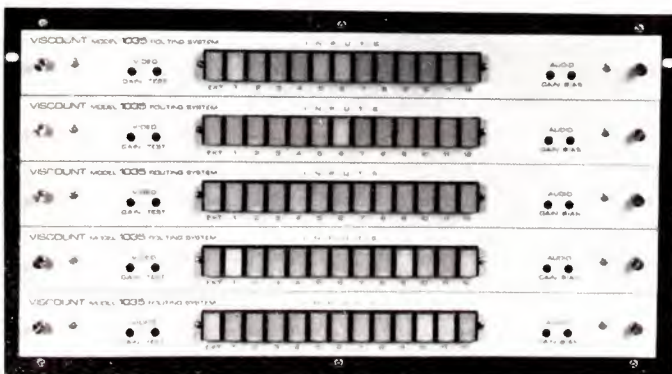

Circle 194 on Reader Service Card



# Change is in the air.



Now you can get more from your telephone. In the studio. On location. In the office.

For example, either our 30A Voice Coupler or our versatile 50A Portable Conference Telephone now allows you the flexibility of using regular telephone lines for remote broadcasts.

In addition, "hot lines" to the police and other news sources give you the news as it breaks.

And new compact switching equipment makes it easier for callers to reach your station, and makes communications more efficient for all your staff.

But with all our increased flexibility and innovative service offerings, one thing hasn't changed: Bell System dependability. Automatic test equipment monitors performance at our place, and we correct most troubles before you notice them at your place. And if you do need to call for help, it's never Long Distance. With us, it's always a local call.

For the whole story of how modern communications can help broadcasting performance and profits, telephone your Bell System Communications Consultant.

**AT&T and your local Bell Company.**



plumbicon color video cameras, to be demonstrated on live cameras. Also new is the line of **camera support equipment**, including heads, tripods, dollies, pedestals, motorized and servo pan heads, lens motorization, complete camera remote control. Also on display: Model 5404B **videotape editing programmer**, Polaris zoom lenses.

### Teledyne Camera Systems (Booth 534).

Television **tape-to-film transfer equipment** for color and monochrome.

### TeleMation, Inc. (Booth 500).

Will introduce: A new line of **video production switchers**, TPS-2006, with 20 inputs, 6 busses, mixing facilities, special effects built in; smaller switches, the TPS-10004; also a compact switcher, the TPS-7A, for vans or small studios. Also introducing the TCE-2000 digital color encoder, and the TED-2 automatic computerized character gen-

erator, with teletypewriter input. Also shown: a new version of the TZF-3000 color film camera.

### Telemet, Inc. (Booth 216).

Will introduce a new **decoder**, Model 4706, designed to put a station's existing RGB chroma keyer in line and provide zero horizontal delay NTSC chroma keying. The unit eliminates chroma crawl and can use different encoded video sources: it can also be interfaced with any part of the system, as long as the system includes an RCB chroma keyer.

### Telestrator Industries Inc. (Booth 531).

Electromotion system for **producing motion pictures** with still cameras; character generators for television.

### Telesync Corp. (Booth 201).

**Prompting equipment systems**, horizontal-vertical crawl; front projection systems.

### Television Equipment Associates (Booth 521).

Will show the following array of

products: Magnetek **tape cleaner** which removes most of dirt from both sides of videotape, and with up to 70% of drop outs; a battery powered **portable headset amplifier** (new) the Colorgard Mark IV meter, which allows quick adjustment

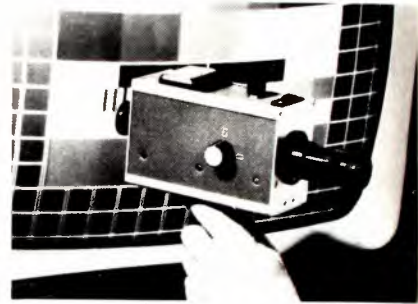

of color balance of any TV monitor; Minilite, super-lightweight headset which can be positioned slightly of the ear for minimum chafing; Ampligard headset for communication; on TV musical productions; (new) Matthey **video delays** (see entry for Matthey Electronics); the Clean Air Shower, which bathes VTR head area in air with 99.97% of dust removed, extends head life; the IRT Comparator, for adjusting color monitor balance.

continued on page 124

# When you get down to camera mounting equipment, there is only VINTEN, from LISTEC.

See all that's new, booth 529, NAB Shoreham

VINTEN Type 723  
Low Angle Dolly.  
Featuring air counter-  
balanced jib with 4½" to  
25½" height range;  
capacity 350 lbs.

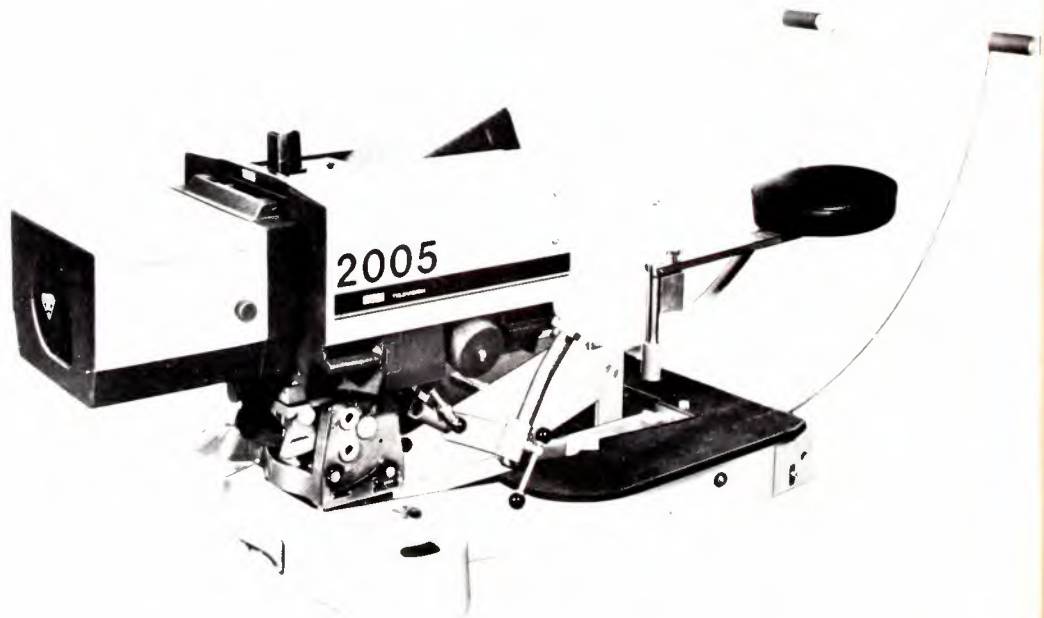

### Listec Television Equipment Corporation

35 Cain Drive, Plainview, New York—11803

tel: (516) 694-8963, 8973 & 8976

Circle 198 on Reader Service Card



# A NOISE FREE AGC AMPLIFIER WITH A DYNAMIC RANGE PRESERVER



WILKINSON ELECTRONICS GCA-1  
STEREO OR MONO

- \* Noise -75db even with loss of input. Automatically "rides" gain without regard to peaks. Exclusive RMS Detector preserves dynamic range. Will not adjust gain if signal removed.
- \* Distortion - 0.1% all gain settings.
- \* Frequency Response -  $\pm 1/4$ db 50HZ to 20KHz any gain setting.

For complete details write:

**WILKINSON**  
ELECTRONICS, INC.

1937 MacDADE BLVD.  
WOODLYN, PA. 19094  
PHONE (215) 874-5236 874-5237

Circle 248 on Reader Service Card

# A LIMITER WITH INSTANTANEOUS ATTACK--LESS THAN 1% DISTORTION



WILKINSON ELECTRONICS LA2-C/S  
STEREO OR MONO

- \* Distortion -  $1/4$ % for 6db of limiting. 1% or less to 20db of limiting.
- \* Attack Time -  $5/4$  Radians for gain control before clipping.
- \* Overlimit Attack Time - Instantaneous.
- \* Compression Ratio - More than 35:1.
- \* Frequency Response - + 1db 50Hz to 35KHz with full limiting.

For complete details write:

**WILKINSON**  
ELECTRONICS, INC.

1937 MacDADE BLVD.  
WOODLYN, PA. 19094  
PHONE (215) 874-5236 874-5237

Circle 199 on Reader Service Card

Now  
you have a third choice  
when you go  
from color tape to film.

**1** The low priced system.  
You call it "kinescope."  
You like the price.  
Not the quality.

**2** The high-priced system.  
You call it "expensive."  
You like the quality.  
Not the price.

**3** Our new Teledyne system.  
You'll call it perfect.

Teledyne at Mediatech is a brand new system that insures consistent broadcast quality transfers at the same cost as the low-priced system. Color or black/white. 16 or 8 mm. From quad or helical tapes.

Give us an opportunity to prove it.  
Send for our price list and further information

**Mediatech**

824 Busse Highway/Park Ridge, Illinois 60068

Name \_\_\_\_\_

Address \_\_\_\_\_

City \_\_\_\_\_

State \_\_\_\_\_ Zip \_\_\_\_\_

824 Busse Highway  
Park Ridge, Illinois 60068  
312/693-8366

Circle 240 on Reader Service Card

# Replace your Ampex or Scully motor with a BEAU MOTOR

Hysteresis-Synchronous Motor

- ◆ Ball Bearing Construction for Years of Trouble-free Operation
- ◆ Electroplated Capstans for Longer Life
- ◆ 0.00015 Inches Max. TIR
- ◆ High Inertia Rotor
- ◆ Low Flutter & Wow Inside Out Construction

Tape Speed	Ampex Model	Scully Model	Beau P/N	Price
3 3/4-7 1/2	440	270 275	43H-108	\$150.00
		280 282		
7 1/2-15	440	270 275	43H-115	150.00
		280 282		
7 1/2-15	350		54H-56	165.00
	351 354			
3 3/4-7 1/2	350		54H-61	165.00
	351 354			



**BEAU MOTOR DIVISION**  
 UMC Electronics Co.  
 460 Sackett Point Road  
 North Haven, Conn. 06473  
 (203) 288-7731

Circle 241 on Reader Service Card

## JOA CARTRIDGE SERVICE OFFERS DISTINCT ADVANTAGES YOU SHOULD KNOW ABOUT

Advantage ONE—NO MINIMUM

### CARTRIDGE RECONDITIONING

- Advantage TWO—NO EXTRA CHARGE for
- (a) foam teflon-faced pressure pads
  - (b) replacement of minor parts
  - (c) visible splice
  - (d) pretesting under actual broadcast conditions
  - (e) 48 hour processing
  - (f) Scotch heavy-duty lubricated tape

### NEW CARTRIDGES

Advantage THREE

Shipment, from stock, of any standard size, or . . . "prompt shipment" of CUSTOM SIZE Fidelipac precision manufactured NAB cartridges

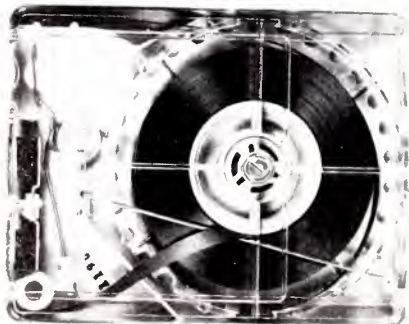

Advantage FOUR—20 or more shipped prepaid  
 Authorized distributor for NORTRONIC HEADS  
 Phone or Write

### JOA Cartridge Service

P.O. Box 3087, Phila., Penna. 19150  
 Area Code 215, 886 7993

Circle 253 on Reader Service Card

# NAB '73

## Television Microtime Inc. (Booth 600).

The Delta 7 Velcor is a new stand-alone **time base corrector**. It interfaces with two-inch quad or one-inch helical VTRs, and in combination with the Delta 44 unit it reduces maximum color phase displacement to less than + 3 ns, referenced to external subcarrier phase, throughout the reproduced picture.

## Telex Communications Div. (Booth 518).

Tape recorder/reproducers; tape duplicating and copying equipment; headphones.

## Time and Frequency Technology Inc. (Booth 605).

Frequency monitors, for audio and TV, which reduce distortion by omitting RF amplifiers; automatic loggers; digital clocks.

## United Research Laboratory

## Corp. (Booth 510).

Autotec professional **tape recorders**; exact duplicate replacement parts for professional recorders of many makes.

## Utility Tower Co. (Booth 204).

Antenna towers for radio and TV.

## Varian Assoc. (Booth 523).

Power tubes, including triodes, tetrodes, pentodes; klystrons.

## Vega Electronics (Booth 310).

Wireless microphones (will be exhibited by Sparta Electronics).

## VIF International (Booth 561).

Background music equipment and services; audio automation equipment; audio tape recorders and players; video test generators, digital timers for video applications.

## Visual Electronics Corp. (Booth 218).

Will introduce: A new **miniature**  
 continued on page 126

# Standard for Precision...

## When accuracy counts.



PANEL MOUNTED



PORTABLE

### Portable or Panel-Mounted

Accuracy to .002 of a second. Built for long, trouble-free service. Easy to read, shatter proof crystal . . . the perfect timer. For full details, request Free catalog No. 261.

Model	Scale Divisions	Totalizes	Accuracy
S-100	1/5 sec.	6000 sec.	±.1 sec.
S-60	1/5 sec.	60 min.	±.1 sec.
SM-60	1/100 min.	60 min.	±.002 min.
S-10	1/10 sec.	1000 sec.	±.02 sec.
S-6	1/1000 min.	10 min.	±.0002 min.
S-1	1/100 sec.	60 sec.	±.01 sec.
MST-100	1/1000 sec.	6 sec.	±.001 sec.
MST-500	1/1000 sec.	30 sec.	±.002 sec.

STANDARD ELECTRIC TIME



DIVISION OF JOHNSON SERVICE COMPANY

89 LOGAN STREET • SPRINGFIELD, MASS. 01101

Circle 242 on Reader Service Card



# FLASH!!

## FAST, FAST, FAST RELIEF FROM THE FCC STEREO BLUES!

If you broadcast FM stereo, you're probably worried about the proposed "Stereo pilot off when broadcasting mono material" rule. Besides, you know that stereo attracts listeners and pleases advertisers.

We build a device that beats the Commission to the punch by creating realistic pseudo-stereo from any mono source material. The Orban/Parasound Stereo Synthesizer is amazingly quick and easy to use, and it's fully mono-stereo compatible.

This is the first time we've advertised in broadcast-oriented media, but we're well-known in professional recording circles. And our Stereo Synthesizer is already used by such blue-chip companies as Elektra, MGM, Capitol, Altophonic, and PAMS, as well as by broadcasters throughout the country. \$749 puts it in your production studio or on the air.

We also build a \$595 reverb that has achieved wide acceptance because of its remarkable price/performance ratio. Unique circuit concepts make it outperform any other spring on the market, including the \$1200 job many of you have grown to know, if not love.

Broadcasters — we need your business. And we're going to get it by offering you well-built, fairly-priced products that really perform.

For more information, write Parasound, Inc., 680 Beach St. #495, San Francisco, Calif. 94109 or call (415) 776 2808.

### ORBAN/PARASOUND: THE AUDIO PROCESSING PEOPLE

Circle 243 on Reader Service Card

## PERFECT YOUR CCTV SYSTEM WITH COSMICAR<sup>®</sup> LENSES



TV-COSMICAR-EE 16mm F/1.6

The TV-COSMICAR-EE 16mm f/1.6 is a high-speed lens specially designed for 2/3" vidicon cameras. It maintains image luminance 100 lx against subject brightness between LV11.3~17 (350~18,000 cd/m<sup>2</sup>), about 1,800~96,000 lx.

The automatic electric-eye diaphragm close down completely provided that subject brightness exceeds approx. LV20 (144,000 cd/m<sup>2</sup>), 768,000 lx. In case the camera is switched off and not in operation, the automatic diaphragm closes down, completely shutting off the light for protection of the vidicon camera.

The "Change-over Switch" in front of the lens controls the operation of the diaphragm.

When the switch lever is turned on to "EE", the lens diaphragm operates as fully automatic electric-eye, and is brought on to "OPEN", the diaphragm stays fully opened condition.

**Be sure to get the finest image recording results with quality Cosmicar lenses.**

Also available are scores of other lenses, ranging from 8.5mm to 1,000mm telephoto, zoom and those motordriven among them, for immediate delivery, after being tailored to your specifications.



## COSMICAR OPTICAL CO., LTD.

424, Higashi-Oizumi, Nerima-ku, Tokyo, Japan

Cable Address: "MOVIEKINO TOKYO"

Circle 244 on Reader Service Card



# NAB '73

audio cartridge system, the "Car-trette;" also new Stereo Phase Corrector to reduce phase error in stereo cartridges. Showing the Rapid Q line of audio cart systems, video switchers with multimix, special effects.

**Vital Industries, Inc.**  
(Booth 219).

Will introduce the new VIX 100-4 video production switcher with a novel special effects generator. Also a computer-controlled master control system; unit supplying digital control for visual graphic displays; digital control of routing switcher; and a full complement of peripheral equipment.

**Wilkinson Electronics, Inc.**  
(Booth 311).  
AM and FM transmitters; audio

consoles; processing amplifiers; FM exciters; stereo and SCA generators

**World Video (Booth 508).**

Will show the new Model 6700 color monitor with Trinitron one-gun tube, mountable in 15 3/4 inches of rack space, with all broadcast-monitor features: pulse cross, high voltage regulation, AV inputs, internal and external sync; weight 75 pounds. Also shown: other color monitors in the series **BM/E**

**SPOTMASTER REBUILDING SERVICE**

CLEANING  
ADJUSTMENT  
DIAGNOSIS  
**\$45**

We will thoroughly clean and adjust your 400 or 500 series SPOTMASTER record play unit for \$45.00. Delay model \$5 extra. Playback unit \$35.00. Any malfunctions or defective parts noted during preliminary testing will be corrected only after customer notification and approval. We are a franchised SPOTMASTER dealer in new equipment, used equipment, and parts.

**COMMUNICATION MEDIAS**  
P.O. BOX 54 ALLENTOWN, PA 18105  
PHONE (215) 437-0607

Ship all equipment freight prepaid.  
New accounts must enclose check with order.  
Circle 245 on Reader Service Card

**STUDIO CRANES**

Reg. **\$12,000**

**NOW \$3,500**

**NOW! At a price every TV station can afford! A \$12,000 ACADEMY CRANE in perfect condition for \$3,500! Call (213) 466-8211 today!**

**BIRNS & SAWYER, INC.**  
1026 NO. HIGHLAND AVE. • LOS ANGELES, CALIF. 90038  
(213) 466-8211 • CABLE: BIRNSAW

Circle 246 on Reader Service Card



CUSTOM FIDELITY proudly presents the first audio console designed specifically for the CATV broadcaster. Although modestly priced, the CA10V represents the ultimate in control flexibility and convenience features.

Some of the features of the Model CA-10V:

- 8 active inputs for up to 32 input sources
- 2 independent program outputs
- Illuminated push button assign switches
- Illuminated V.U. meters
- Professional straight-line slide level controls
- Plus channel muting, separate monitor circuits
- Talkback, audio following, etc.

For more information call or write  
**CUSTOM FIDELITY COMPANY, Inc.**, 7925 Santa Monica Blvd.  
Hollywood, California 90046 (213) 654-7111

Circle 247 on Reader Service Card



**can your  
fm  
antenna  
do this...**

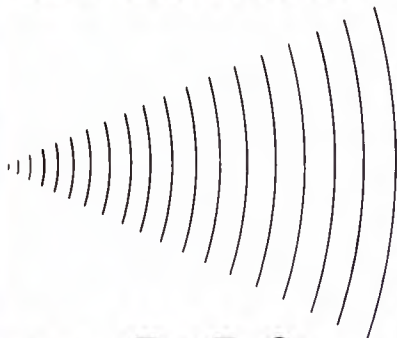

**and this..**



**if not,  
let's  
trade.**

Trade in your weak signal for one that reaches into those difficult fringe areas, car receivers, small portables. "Trade-in" your old PULSE and ARB ratings for better ones.

Trade your old antenna for our "Penetrator." It's the only patented circularized FM antenna. The "Penetrator" features will meet your exact horizontal-to-vertical ratio requirements and save you money, too!

Built to last with marine brass and thick-wall copper, the "Penetrator" features low wind resistance, lightweight, high power capabilities, and wide VSWR band widths of 1.08 to 1 +200 KC.

Your antenna does have trade-in values. Write us today for prices, catalog and trade-in details.

**J**

**A**

**M**

**P**

**R**

**O**

**ANTENNA  
COMPANY**

A DIVISION OF  
COMPUTER EQUIPMENT  
CORPORATION

(916) 383-1177

6939 POWER INN ROAD  
SACRAMENTO, CALIF.  
95828

**WORLD'S BEST  
2.5 KW FM TRANSMITTER  
USING  
ONLY ONE TUBE**

- USES (1) 5CX1500
- SOLID STATE EXCITER
- SOLID STATE IPA
- SOLID STATE SUPPLIES
- SOLID STATE CONTROL
- FM NOISE, -65 db
- 1/2 db, 30 H -35 KHz
- VAC.CAP. TUNING
- VAC CAP. LOADING
- NO SLIDING CONTACTS
- NO NEUTRALIZATION
- 2750 WATTS AVAIL-  
ABLE
- NEEDS ONLY 5 1/2 sq. ft.
- COMPLETELY ACCESS-  
IBLE
- FCC TYPE-ACCEPTED

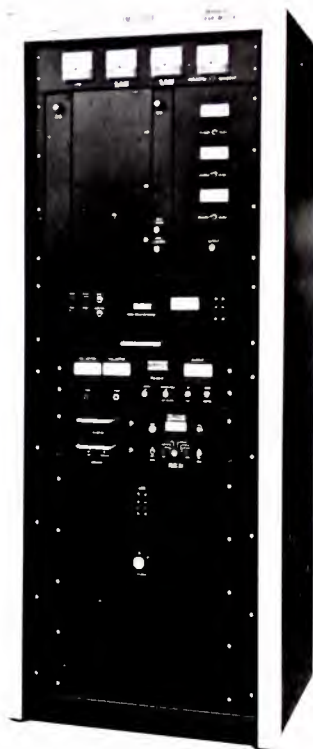

ONLY THE WILKINSON FM-2500E HAS ALL THESE FEATURES YET IS PRICED LESS THAN \$9,000.00.

**WILKINSON  
ELECTRONICS, INC.**

1937 MacDADE BOULEVARD  
WOODLYN, PA. 19094  
TELEPHONE (215) 874-5236 874-5237

Circle 250 on Reader Service Card

Circle 249 on Reader Service Card

## TWO NEW TEST INSTRUMENTS FOR DIRECTIONAL ANTENNAS



**FSM-1  
FIELD STRENGTH METER**  
 Frequency: Any frequency in the AM band  
 Field Strength Range: 100 $\mu$  V/m to 1V/m  
 Power: Internal battery  
 Calibration certificate supplied  
 Size: 5-1/2" x 8" x 5"  
 (closed); Weight: 4-3/4 lbs. with batteries

**DAM-1 DIGITAL ANTENNA MONITOR**  
 Frequency: Any frequency in the AM band; Phase Range:  $\pm 180^\circ$ ;  
 Phase Accuracy:  $\pm 1.0^\circ$ ; Phase Resolution:  $\pm 0.1^\circ$ ;  
 Ratio Range: 0.100 to 2.000; Ratio Accuracy:  $\pm 2.0\%$ ;  
 Ratio Resolution:  $\pm 0.001$ ; Input Impedance: 50 or 75 ohms



Delta's new Field Strength Meter and Digital Antenna Monitor will help keep your directional antenna system within FCC specifications.

The DAM-1 Antenna Monitor meets the new FCC requirements for remote control. It is a true digital instrument using the latest integrated circuit and TTL techniques. Reads phase and true current ratio for up to six towers with different reference towers and different powers for DA-2. Monitors for larger arrays available on special order.

Delta also offers remote panels and interface units for controlling and reading the DAM-1 Phase Meter over multiconductor, two wire, UHF, or microwave circuits with no reduction in accuracy.

The FSM-1 Field Strength Meter is smaller and much simpler to operate than other field strength meters because it is fixed tuned to your frequency by plug-in modules. If you have to check more than one station, order the FSM-1 with additional frequency modules. For monitor point checks and extensive proof of performance work the FSM-1 will minimize errors and speed up field measurements.

DELTA ELECTRONICS, Department B  
 5534 Port Royal Rd., Springfield, Va. 22151  
 703/321-9845

**DELTA ELECTRONICS**

NAB Show • Booth 532

Exporter DELTA ELECTRONICS, INC.  
 International Division, 154 E Boston Post Rd  
 Mamaroneck, N. Y. 10543. Telex 1 37327, Art Rocke



Circle 255 on Reader Service Card

# FROM THE EDITOR

## Some Visceral Reaction to Radio and Programming Deregulation

The recent Long Island Railroad strike helped us to know radio as never before. For a while the experience was interesting and exciting—the one-and-a-half to two-hour drive each day provided ample opportunity to sample the AM dial.

Prior to this extended listening experience, we really didn't know radio intimately except for a few pet likes and hates—such as WGBS all news radio and WABC respectively. The latter came on automatically every time one of our teenagers had used the car. Over the year we eventually adjusted to the music—even liking some of it—but WABC's breathless announcing style, with verbiage no less, still sends us up the wall. WGBS was our station. But all-news wears thin when you hear it recycled four or more times an hour. We tested WABC news for a day to see if they would inject a little more variety—there was less and the delivery duller.

We tried "Rambling With Gambling" one morning. Between traffic reports, news, commercials, sundry other reports, and more commercials we actually heard Gambling utter maybe several hundred words. Since we have no reason to feel loyal to Mr. G, we can report he struck us as most desultory (which is somewhat of a synonym for rambling) and lusterless. Maybe it was an off day for him. Earlier we'd been amused by WISW and WHF (really zany morning commentary), but since we didn't identify with any of the personalities they were, a best a diversion.

For straight rounded pleasant listening—music and news—the local Long Island and Westchester (New York), New Jersey and Connecticut stations served our purpose. But the cloddy, humorless (even when they tried), hard-sell commercials that blasted us every three minutes were unmerciful—and more than we could take. Not having a classical car, thank God for WPAT

"Pet hates during January, Sheraton Hotels' singing commercials. "What has Sheraton done for you lately." Overly loud and annoying (they haven't done anything for me). Another was Mobil O on the energy crisis. "What would you do?" they asked. Nam one alternative to Mobil's dipping holes—all over and you label your self a moron. Categorically offensive was the Oldsmobile dealer's New York Mafia glorifying promotion of the H. Squire.



## MAINTAIN YOUR ANTENNA SYSTEM AT PEAK EFFICIENCY



**Model OIB-1**  
Operating Impedance Bridge measures in circuit impedance of networks transmission lines and antennas. Accuracy  $\pm 2\% \pm 1 \text{ Ohm}$ . Power rating, 5 kW modulated; 10 kW CW — VSWR 3: 1.



**Model RG-1**  
Receiver/Generator combines a high output power signal generator with a shielded receiver for use with Model OIB-1 or any other impedance bridge.



**Model CPB-1** Common Point Bridge measures resistance to  $\pm 2\% \pm 1 \text{ Ohm}$  and reactance to  $\pm 5\% \pm 1 \text{ Ohm}$  at full power.

With Delta's monitoring equipment, you can either "spot check" or continuously and accurately monitor actual "on-the-air" operating impedance of transmission lines, networks and antenna systems to maintain a "clean signal" peak operating efficiency.

If you're operating with a directional antenna, there's real value in being able to keep the radiating system in close adjustment at all times. . .continuously verify common point impedance to insure full power output. . .plus locating and correcting any antenna problems — fast!

Complete details and application data are available without obligation — just write or call Bill Cottles, DELTA ELECTRONICS, INC., Department B, 5534 Port Royal Road, Springfield, Va. 22151 703/321-9845.

**DELTA ELECTRONICS**



NAB Show • Booth 532

Exporter: DELTA ELECTRONICS, INC.  
International Division, 154 E Boston Post Rd.  
Mamaroneck, N. Y. 10543, Telex 1 37327, Art Rocke

Circle 256 on Reader Service Card

Actually, we enjoyed a lot of the creative efforts of New York City admen. They were infinitely easier to take than some of the local home brew stuff—unless they happen to insult you which occurs frequently.\*

We tried one morning New York's municipal station, WNYC. If you want a lesson in why radio has to be entertaining, try WNYC. Even the traffic reports are murder. WNYC gets reports from police helicopters. Although the guys make a valiant effort to be personal, their delivery styles simply don't move any faster than the traffic they are reporting. If you want a lesson on the need for good signal-to-noise, WNYC helicopter reports offer that too. S/N must be 5-to-1 or worse at times, and when it's that bad, the information had better be exciting.

We stayed with WNYC for two hours that morning and, although it was never entertaining, we did learn how to buy and fry fish. And we heard of one job opening. If you could tune in some of WNYC's information reports on *your* schedule, rather than *theirs*, the station might serve some function. Maybe they ought to make audio cassettes available at news stands instead.

Although morning drive-time radio was an inadequate substitute for an hour's reading time on the train, in our judgment, five-to-seven p.m. radio was appalling. The most disturbing thing was the lack of variety. From six o'clock on there was no choice. The suburban stations went off the air at sundown. It seems every New York station, including those nominally music or news, feature during this time slot a call-in sports show. If you aren't a sports nut, there is nothing to listen to. The only alternative is to tune in an ethnic station or play the dial for a Canadian station that might skip for ten minutes or so.

The frightening aspect of the sameness or me-too-ism is that, if radio would be truly de-regulated by the FCC, it might not offer more diversity at all. Instead it would be ARB regulated—if sports call-in shows are the listeners' preference one week, that's what we'll get from everybody next week. Some stations split their personality between a.m. and p.m. to be part of the crowd. Extremely disturbing.

It makes you wonder what would really happen if the Office of Telecommunications Policy proposed revision of the Communications Act is adopted. There is certainly merit in eliminating the FCC requirement calling for certain percentages of this type programming and that. In a multi-station market, who needs it? You'd assume one station could be all-news, another all-religion, still another classical music. Such an arrangement would be better than forcing a teen-age rock station to do public affairs on housing problems. OTP's Whitehead made an appealing point when he declared the licensee, and not the FCC with its quotas, should determine what serves local needs. But after our stint of radio listening, we're less sanguine about the results.

We're reminded that our free economic system polluted the air we breathe until legislation forced it to do otherwise. That's no criticism of the free enterprise system. It is simply an acknowledgment that when the score is counted by profits earned, there will be pollution unless there are rules. No rules means broadcasting can pollute the air with call-in sports shows. Or it can limit the size of the music play list when it discovers top-40 MOR wins ratings. It can buy up a classical station and switch to C&W.

We are four square in favor of less regulation and minimum government control. But this much we acknowledge: Radio and TV today is more responsive to the community than ever before because it can be so readily challenged by the public. When there are standards to be met and criteria to judge by, quality improves.—JAL



# BM/E CLASSIFIED MARKETPLACE

## CLASSIFIED ADVERTISING RATES

DISPLAY CLASSIFIED ADVERTISING: \$22.50 per inch 1x; \$22.00 per inch 3x; \$21.00 per inch 6x; \$20.00 per inch 12x. ALL OTHER CLASSIFIED ADVERTISING 25¢ per word; minimum \$3.00. BLIND BOX NUMBER: No extra charge. Replies sent to address below will be forwarded to you. PAYABLE IN ADVANCE; send check with order. CLOSING DATE: 5th of 2nd month preceding issue date.

BM/E, Monterey and Pinola Avenues, Blue Ridge Summit, Pa. 17214

Phone 717/794/2191

## HELP WANTED

### BROADCAST FIELD ENGINEERS

#### WE ARE EXPANDING

If you are experienced in maintenance of color studio equipment we have an excellent growth opportunity for you in a new career with challenge and real advancement possibilities.

Write: Sarkes-Tarzian, Inc.  
Broadcast Equipment Div.  
E. Hillside Drive  
Bloomington, In. 47401

WANTED IMMEDIATELY, Video Tape Engineer. Excellent Salary. Live near the top ski areas of the Rocky Mountain West. America's cleanest air. Contact collect: Scott Tipton, Opr. Dir., KYCU-TV, Cheyenne, Wyo. (307) 634-7755.

We are looking for additional Reps to sell our products. Must already be in broadcast equipment sales field. Send photo and resume to Box 373-6, c/o BM E, Blue Ridge Summit, Pa. 17214.

### CATV SALESMAN

Well established Midwestern NYSE corporation is seeking highly-motivated salesman with good technical background in communications or electronics who is willing to do considerable travelling.

Salesman will deal directly with cable system operators selling CATV equipment and hardware.

Must be willing to relocate to Midwest. Position offers excellent salary and fringe benefits including profit sharing. Send resume and salary requirement in confidence to:

Box 373-2, c/o BM/E,  
Blue Ridge Summit, Pa. 17214

An Equal Opportunity Employer

Television Tech, experienced operation and maintenance of color cameras, video tape recorders, etc. Willing to travel and share driving. Good pay for good man. Send resume stating experience and salary requirements to Box 373-5, c/o BM E, Blue Ridge Summit, Pa. 17214.

### TELEVISION DEVELOPMENT ENGINEERS

#### WE ARE EXPANDING

If you are now doing development work in TV equipment we have an excellent growth opportunity for you. We need engineers skilled in analog & digital circuit design to join in the development of equipment which is at the forefront of the state of the art. You can see some of it at NAB—in the meantime—contact Al Busch. 812-332-7251.

SARKES TARZIAN, INC.

BROADCAST TRANSMITTER DESIGN ENGINEER. Expanding Midwest company seeking qualified RF design engineer for development of FM RF Amplifiers to 40 KW and 5.10 KW AM amplifiers. EE degree or equivalent experience necessary. Confidential replies to: Box 373-4, c/o BM E, Blue Ridge Summit, Pa. 17214. EQUAL OPPORTUNITY EMPLOYER.

Established station in all U market needs maintenance supervisor with experience in VTR's and color cameras. Salary commensurate with experience. Equal Opportunity Employer. Send resume to Box 373-3, c/o BM E, Blue Ridge Summit, Pa. 17214.

Christian Radio Station, Midwest—established—needs station manager. Send tape and photo to Box 373-1, c/o BM E, Blue Ridge Summit, Pa. 17214.

Position immediately available for competent maintenance engineer familiar with all types of helical scan equipment in exciting, expanding company. Previous experience absolutely necessary. Management potential essential. Please call John Anthony, (212) 757-3681, collect.

## EQUIPMENT FOR SALE

### TV EQUIPMENT INVENTORY CLEARANCE

### STUDIO QUALITY COLOR CAMERAS

## NEW

\$12,000 (Less PbO tubes) 6 Available

CONTACT: SARKES-TARZIAN, INC.  
Ron Adamson (812) 332-7251

#### WE ARE EXPANDING

USED EQUIPMENT FOR SALE ON BIDS. Collins 250 Watt FM transmitter model 830B-1B with 310Z solid state exciter, tuned to 91.1 MHz. Includes one spare set of voltage regulator tubes, 3 years old Marti FM antenna (4 bay) model FA-4, Marti remote control system model RMC-2AX(10), includes RMC-2AXS studio unit and RMC-2AXT(A) transmitter unit, Marti STL package tuned to 94.5 MHz, including M-3 STL transmitter with low pass filter, MR 200 942-952 receiver, 2 E-948G parabolic antennas (4 foot dishes) and K-9629 mounting kits. Used 2 years. All preceding in excellent condition. Andrew 7" helix type FH5 50, 350 ft. type FHJ5-50, 300 ft., and type HJ5-50, 50 ft. For information, contact Michigan Technological University, Purchasing Department, Houghton, Mich. 49931. Telephone (906) 487-2510.

U.S. GOVERNMENT SURPLUS. Save 75% on video tape! De-gaussed, guaranteed! Top brands—Scotch, Ampex, Memorex 1 1/2" x 7200', \$12.50; 1" x 3600', \$10; 2" x 3600', \$15. Brand New Ampex 779, 2" x 3600', \$25; 10' \$25. FOB Houston. GENSCO, Box 14628, Houston, Texas 77021. (713) 748-3350.

PROTECT valuable broadcast property from fire, theft, with a Soni-Tel Alarm System. HBC Sales, Box 189, Haynesville, La. 71038.

QUALITY AUDIO CONSOLES are our specialty. Modern styling with slide potentiometers and "soft" audio switching. We manufacture eight standard consoles at very competitive prices. However, we'll manufacture a custom system to your specifications if you prefer. Also, plug-in audio modules including distribution amplifiers, etc. Write or phone for pricing and specifications. SYSTEMS ENGINEERING COMPANY, P.O. Box 49224, Atlanta, Ga. 30329. (404) 482-2446.

Trompeter Video Jacks, Types J-3 or J-9, \$3 each. Video Panels Trompeter JSWI-24 or JSI-24L, \$30. IVC 800 Video heads \$150. GR 916A Impedance bridge \$250. Satisfaction Guaranteed. Deduct 10% for cash. Norman Gillaspie, Box 2124, Monterey, CA. 93940 (408) 375-7424.

SCULLY TAPE RECORDERS: Mono, 2, 4, 8, 12, & 16 track models plus 270 automatic players. Some models in stock now. W.A.L. custom audio control console & console modules. Solid state 120 Watt power Amps. We buy and rebuild Scully lathes. WIFGAND AUDIO LABORATORIES, INC. R.D. 3, Middleburg, Pa. 17842. 717-837-1444.

## EQUIPMENT FOR SALE (Cont'd)

CARTRIDGE TAPE EQUIPMENT—Rebuilt. New paint, heads, flywheel, pressure roller, belts etc. Spotlessly clean and thoroughly tested. 30 day money-back guarantee. 90 day warranty. Also contact us for possible discounts on new equipment and accessories.

AUTODYNE, Box 1004,  
Rockville, Maryland 20850  
(301/762-7626).

MOTORS FOR SPOTMASTERS  
NEW Papst hysteresis synchronous motor HSZ 20.50-4-470D as used in series 400 and 500 machines. Price \$39.00 each prepaid while they last. 90 day warranty. Terms check with order only, no COD's. Not recommended for Tapecaster series 600 or 700.

TAPECASTER TCM, INC., Box 662  
Rockville, Maryland 20851

Solid-state audio modules-console kits, power amplifier kits, power supplies. Octal plug-ins—mic, eq. line, disc, tape play, tape record, amplifiers. Audio & tape bias oscillators. Over 50 audio products. Send for free catalog and applications. Opamp Labs, Inc., 172 So. Alta Vista Blvd., Los Angeles, Calif. 90036. (213) 934-3566.

AMERICA'S LARGEST STOCK AND ASSIGNMENT LISTING of new and used broadcast and recording equipment. We trade-sell and buy. THE MAZE CORPORATION, P.O. Box 6636, Birmingham, Ala. 35210.



**EQUIPMENT FOR SALE (cont'd)**

Alford type 1052 Duplexing Filter, 500 ft. rigid 1-1/2" coax with bullets and hangers, 5 sections, Alford Ch. 9 Antenna. All in excellent condition, priced to sell individually or as a package. Contact Reggie Moffatt, Mid-Fla TV Corp., PO Box 6103 C, Orlando, Fla. 23803 or phone (305) 841-5040.

**FIDELIPAC CARTRIDGES**, NAB approved factory new. All carts have minimum of 6 minutes worth of tape. Sold in cartons of 50 units only \$1.00 each. Send check with orders. Satisfaction guaranteed. Gately Electronics, 57 W. Hillcrest Ave., Havertown, Pa. 19083.

**FIELD STRENGTH METER**, 540 KHz to 10MHz, Ten microvolts to 10 volts per meter. Very solid state design, long battery life. Stable accurate calibration. Free literature. Solar Electronics, 901 No. Highland Ave., Hollywood, Cal. 90038.

**EBS RECEIVERS**—FM type, completely reliable. Built-in monitor and alarm, rack-mount, solid state, only \$149.50 plus shipping. Trionics Professional Electronics, 829 Eighth St., Lillington, N.C. 27546.

**FACTORY LOADED FIDELIPAC CARTRIDGES**, SPOTMASTER new-used-parts-service, over 40 manufacturers, immediate delivery. COMMUNICATION MEDIAS, Box 54, Allentown, Pa. 18105 (215) 437-0607.

**JAPSTAN IDLERS** for AMPEX 300, 35 440 series, self aligning with replaceable ball bearings, \$22.50 net. VIF INTERNATIONAL, Box 555, Mtn. View, Ca. 94040.

The complete and reliable source for new and used broadcast equipment. Request our free listings. Broadcast Equipment and Supply Co., box 3141, Bristol, Tennessee 37620.

**500VAC AND VACUUM** transmitting capacitors, large stock; immediate delivery. Price lists on request. SURCOM ASSOCIATES, 1147 Venice Blvd., Los Angeles, Cal. 90015 (213) 382-6985.

**JAMES FM EXCITER** Model M5534. Good condition. Selling one of our spares, WTUL station #1, Charlottesville, VA. 22904. (703) 77-7734.

**Raytheon Transmitter parts** for RA-250, RA-000A and RA-5A AM transmitters. Raytheon reformer repair service available. Write for prices and information. CA Service, Springfield, VT. 05156.

**CA BTF-5A kw FM transmitter**, Available February. Reasonable. Also, plate transformer or BTF-3B. Contact Chief Engineer, WDBQ, Dubuque, Iowa. (319) 583-6471.

**Surplus Audio Patch Panels** All Standard Configurations. Gulf Telephone & Electronics, Inc. 235 Beverly Hill, Houston, Texas 77027.

—650 ft. towers \$6500.00 each. Many more. Ground wire 85¢ per xx lb. Bill Angle, Box 5, Greenville, N.C. 27834. Tel. 919-752-3040.

One stop for all your professional audio requirements. Bottom line oriented. F.T.C. Brewer, Box 8057, Pensacola, Fla. 32505.

**EQUIPMENT WANTED**

Used TR 70 B, fully equipped and in good condition, needed immediately by New York production company. Call: (212) 757-3681.

**TECHNICAL SERVICES**

**CUSTOM CARTRIDGE RELOADING** and re-urbing. Fidelipac replacement parts and cartridges. Write us today for prices. PROFESSIONAL AUDIO SERVICES, BOX 1953, FT. WORTH, TEX. 76101.

**BUSINESS OPPORTUNITIES**

**RADIO STATION FOR SALE**—5000 Watt AM . . . Eastern Arizona . . . \$175,000 . . . Substantial Cash . . . Harold Bruzee, KHIL, Willcox, Ariz.

**PROGRAM SERVICES**

**#** **TAPES FOR AUTOMATION**

**THE *CnB* STUDIOS**  
Specializing in Custom Services

3415 BERESFORD AVENUE  
BELMONT, CALIFORNIA 94002  
415 / 592-6149

**PROGRAM SERVICES (cont'd)**

"Free" Catalog . . . Everything for the deejay! Comedy, books, airchecks, wild tracks, old radio shows, and more! Write: Command, Box 26348-A, San Francisco 94126.

**Deejays**—Top flight humor. Clean, good for belly laughs. Try it, you'll like it! Sample collection #1: 200/ \$1. Tivoli Comedy Service, 1256 State, Alton, Ill. 62002.

**Deejays!** 11,000 classified gag lines. \$10.00. Unconditionally guaranteed. Comedy catalog free. Edmund Orrin, Box 679-M, Mariposa, Cal. 95338.

**INSTRUCTIONS**

**FCC FIRST CLASS RADIOTELEPHONE LICENSE IN SIX WEEKS**. Classes in El Paso, Dallas, Atlanta, Chicago, Cincinnati, Denver, Ft. Worth, Hartford, Houston, Memphis, Miami Beach, Milwaukee, Minneapolis, Nashville, New Orleans, Oklahoma City, St. Louis, San Antonio, San Francisco, and Seattle. For information contact Elkins Institute, 2727 Inwood Rd., Dallas, Tex. 75235 214/357-4001.

First phone through tape recorded lessons at home plus one week personal instruction in Washington, D.C., Atlanta, Boston, Detroit, New Orleans, Minneapolis, Seattle, Denver, Portland, Los Angeles. Proven results. Our 17th year teaching FCC license courses. Bob Johnson Broadcast License Training, 1060D Duncan, Manhattan Beach, Calif. 90266, 213-379-4461.

**ATTENTION VETERANS!** First class license in five weeks with complete theory and R.C.A.-equipped laboratory training. Approved for veterans Tuition \$333.00. Housing cost \$16.00 per week. American Institute of Radio, 2622 Old Lebanon Road, Nashville, Tenn. 37214. 615-889-0469.

**CONSULTANTS**

**COHEN & DIPPELL**  
CONSULTING ENGINEERS  
Formerly GEO. C. DAVIS  
527 Munsey Bldg.  
(202) 783-0111  
Washington, D. C. 20004  
Member AFCEE

**JANSKY & BAILEY**  
TeleCommunications Consulting  
Department  
**CATV & CCTV**  
Phone 703/354-3400-ext. 722 or 2400  
Shirley Hiway at Edsall Road  
Alexandria, Virginia 22314  
Atlantic Research Corporation

**BROADCAST STUDIO DESIGN**  
*Control Systems, Facilities Planning,  
Plant Layout & Manufacturing*  
**DYMA ENGINEERING, INC.**  
Route 1, Box 51, Taos, New Mexico 87571  
Phone: 505/758-2686

**RALPH E. EVANS ASSOCIATES**  
Consulting Radio Engineers  
AM - FM - TV - CATV - ITFS  
3500 North Sherman Blvd.  
**MILWAUKEE, WISCONSIN 53216**  
Phone: 414-442-4210

**McCLANATHAN & ASSOCIATES**  
*consulting engineers*  
Applications & Field Engineering  
Turnkey Installations—Radio & TV  
*Domestic & Foreign*  
P.O. Box 750  
Portland, Oregon 97207  
Phone: 503/246-8000

**VIR JAMES**  
CONSULTING RADIO ENGINEERS  
Applications and Field Engineering  
Computerized Frequency Surveys  
345 Colorado Blvd.—80206  
(303) 333-5562  
**DENVER, COLORADO**  
Member AFCEE

**ADVERTISERS' INDEX**

American Electronic Laboratories Inc.	16
American Telephone & Telegraph Co.	119
Amperex Electronic Corp.	63
Ampex Corp.	55
Angenieux Corp. of America	78
Audio Devices, Inc.	109
Audio-Video Engineering Co.	116
Automated Processes Inc.	107
Beau Motor Division, UMC Electronics Co.	124
Belar Electronics Laboratory Inc.	98
Birns & Sawyer, Inc.	126
Bonneville Program Services	88
Bosch Corp., Robert, Fernseh Div.	58, 59
Broadcast Electronics Inc.	87, 108
Broadcast Products, Inc.	99, 101, 112, 114
CBS Laboratories, A Division of CBS Broadcast System, Inc.	99, 101, 103
CCA Electronics Corp.	116, 132
CMX Systems	47
Canon Inc.	75
Canon USA Inc.	93
Central Dynamics Ltd.	113
Cerro Wire & Cable Co.	CM/E-13
Cetec Inc.	39
Charles Machine Works Inc.	CM/E-7
Cinema Products Corp.	28, 29
Collins Radio Co.	23
Communication Medias	126
Conrac Division, Conrac Corp.	43
Corley Ltd., D & S	18
Cosmicar Optical Co., Ltd.	125
Custom Fidelity Co., Inc.	126
Datatron Inc.	14
Datavision Inc.	110
Delta Electronics	128, 129
Dynair Electronics Inc.	3
Dynasciences Corp.	33
Echo Science Corp.	84
Eimac Division of Varian	13
Electronic Industrial Engineering	51
Extel Corp.	57
Fairchild Sound Equipment Corp.	103
Fidelipac Div. of Telepro Industries Inc.	18
Flickinger Inc., Daniel	53
Fort Worth Tower Co., Inc.	114
Gates Division, Harris	91
Gotham Audio Corp.	111
Grass Valley Group Inc., The	5
International Good Music, Inc.	112
International Tapetronics Corp.	8
International Video Corp.	CM/E-18, 19
JOA Cartridge Service	124
Jampro Antenna Corp.	123
Jerrold	CM/E-2
LPB Inc.	94
Lamb Laboratories	86
Lenco Electronics	20
Listec Television Equipment Corp.	122
McMartin Industries Inc.	92
Magna-Tech Electronic Co., Inc.	117
Magnavox CATV Division	CM/E-11
Mediatech	123
Micro-Trak Corp.	100
3M Company, Mincom Division	30, 106, 107
Moseley Associates, Inc.	19
North American Phillips Corp., AKG Division	70

continued on page 132

# YOUR BEST COMBINATION FOR FM COVERAGE!!



25KW FM

CCA offers a complete line of field proven FM transmitters from 10 watts to 50KW. Features include 75% plate circuit efficiency, minimum tube life 10,000 hours with zero bias triodes, 65 db signal to noise, distortion less than 0.3%.



## CCA TRUE CIRCULAR ANTENNA

CCA circular antennas are available in low and high power versions with antennas from one bay to 16 bays. Null fill and beam tilt together with radomes permit the broadcaster to obtain coverage where he desires with reliability.

**CCA ELECTRONICS CORPORATION**  
GLOUCESTER CITY, NEW JERSEY 08030 • (609) 456-1716

Canadian Subsidiary:  
**CALDWELL A/V EQUIPMENT CO., LTD.**  
1080 BELLAMY ROAD, NORTH  
SCARBOROUGH, ONTARIO, CANADA  
Phone: (416) 291-5595  
NO. 1 AM & FM

## ADVERTISERS' INDEX

continued

Parasound .....	125
Plastic Reel Corp. of America .....	10
<b>RCA</b> .....	40, 41
Rank Precision Industries, Inc. ....	121
Rapid-Q .....	101
Recortec Inc. ....	15
Revox Corp. ....	86
Richmond Hill Laboratories, Inc. ....	21
Rohde & Schwarz .....	79
<b>SC Electronics, Inc.</b> .....	17
Sarkes Tarzian, Inc. ....	11
Schafer Electronics Corp. ....	49, 103
Scully/Metrotech .....	Cover 2
Sennheiser Electronic Corp. ....	35
Shibaden Corporation of America .....	37, 115
Shively Labs, Inc. ....	105
Shure Bros. ....	45
Sitco Antennas .....	CM/E-20
Sparta Electronic Corp. ....	7
Standard Electric Time Div. of Johnson Service Co. ....	124
Stanton Magnetics Inc. ....	71
Superscope Inc. ....	104, 105
Systems Wire and Cable .....	CM/E-9
<b>TAB Books</b> .....	95, 96, 97
Tape-Athon Corp. ....	80
Tapex Corp. ....	88
Technology Inc. HF Photo Systems Div. ....	104
Tektronix .....	9
Tele-Cine Inc. ....	24
Telemet, A Geotel Company .....	Cover 3
Television Equipment Associates .....	94
Television Microtime, Inc. ....	12
Telex Communications Div. ....	90
Thomson CSF Electron Tubes Inc. ....	102
Time & Frequency Technology Inc. ....	89
Tracor Industrial Instruments .....	92
<b>Ultra Audio Products</b> .....	114
Unimedia, Universal Media Corp. ....	26
United Systems Corp., A Subsidiary of Monsanto .....	48
<b>Video Data Systems</b> .....	CM/E-20
Videomax Corp., Sub. of Orrox Corp. ....	Cover 4
Viscount Video Inc. ....	120
Vital Industries Inc. ....	22
<b>Wilkinson Electronics Corp.</b> .....	27, 127
World Video Inc. ....	118

## SALES OFFICES

**Broadband Information Services, Inc.**  
274 Madison Avenue  
New York, New York 10016

### EASTERN STATES

274 Madison Avenue  
New York, New York 10016  
212-685-5320

Charles C. Horner

### MIDWESTERN STATES

New York Office

### WESTERN STATES

1111 Hearst Building  
San Francisco, California 94130  
415-362-8547

William J. Healey

16400 Ventura Blvd.  
Encino, California 91316  
213-981-4721

Art Mandell

### JAPAN

Nippon Keisoku Inc.  
P.O. Box 410  
Central Tokyo, Japan  
Tokyo (03) 667-7681  
Yoshi Yamamoto



# TELEMET ANNOUNCES ZERO HORIZONTAL DELAY NTSC CHROMA KEYING.

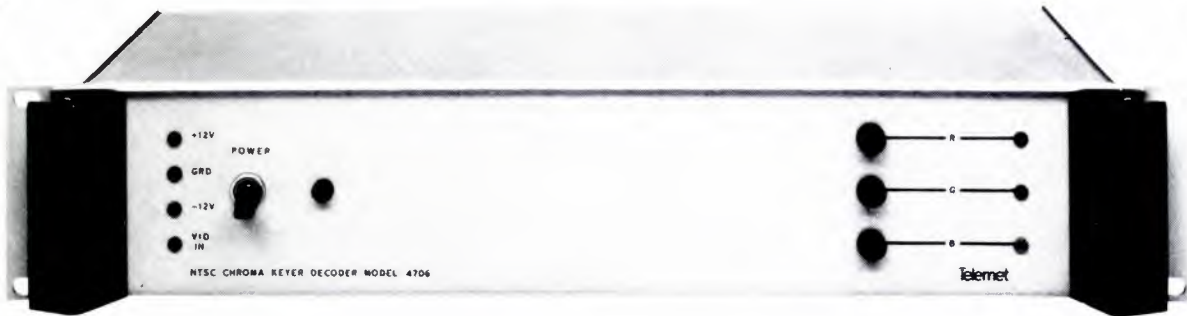

**For only \$1,650, our new Decoder will put your RGB Chroma Keyer in-line, with absolutely no H delay.**

Chroma crawl is eliminated. You can use different encoded video sources, too. Including color TV cameras (standard and triaxial cable), video tapes, remotes, or any other composite NTSC signal. And, you're not restricted to any particular one.

What's more, our Decoder can be used in any part of your system.

Interfacing is totally uncomplicated, even if your RGB Keyer isn't a Telemet model.

And the price is right. Just \$1,650 for the Decoder. And, by the way, a complete Decoder/Keyer system from Telemet costs about as much as a competitive system that doesn't even provide zero H delay.

So, whether you need just a Decoder to integrate with your present RGB Chroma Keyer, or a Decoder/Keyer combination, Telemet can bring you Zero H Delay now.

For all the facts, write or call Telemet,  
Amityville, N.Y. 11701, (516) 541-3600.



better ideas for broadcasting  
**Telemet** A GEOTEL COMPANY

Amityville, New York 11701, (516) 541-3600

#### REGIONAL OFFICES

Chicago Ill (312) 627-6026 Atlanta, Ga (404) 361-2951 Houston, Tex (713) 946-5796 Santa Ana, Calif (714) 540-6756

See us at NAB — Booth 216

Circle 251 on Reader Service Card

# The choice is yours

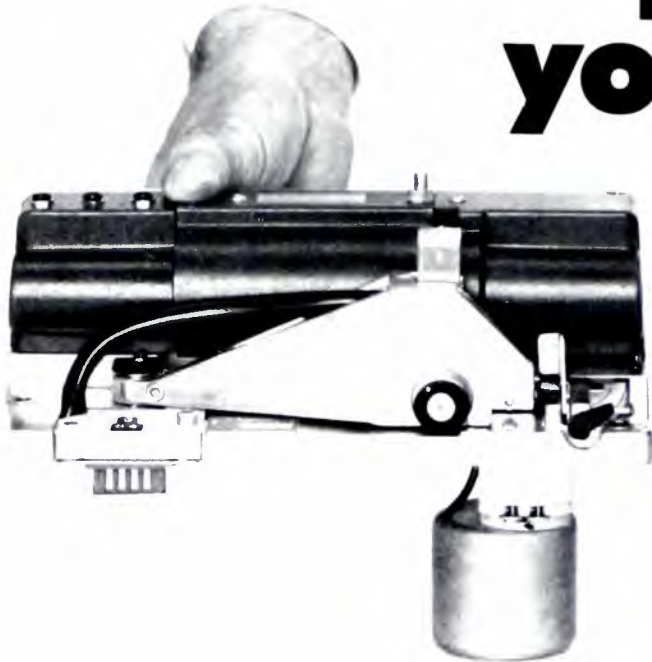

**Ampex-rebuilt  
VTR quad head.  
Good as new.  
125 hour warranty.  
\$810.00**

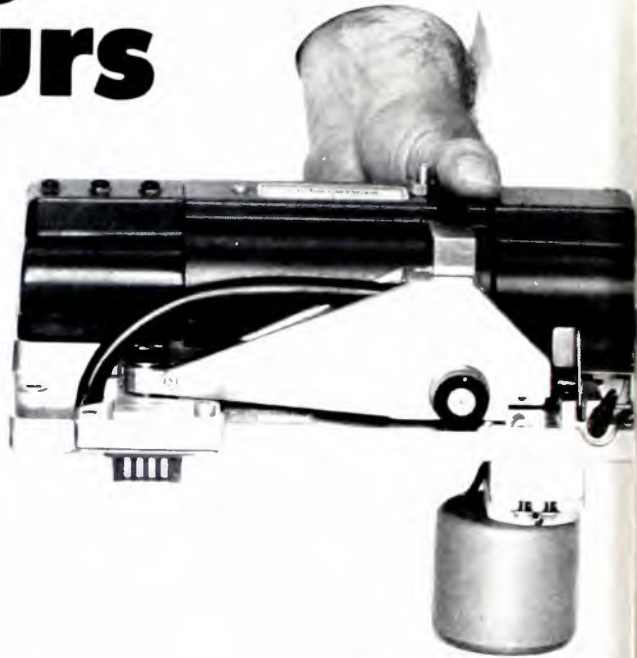

**Videomax-rebuilt  
VTR quad head.  
Better than new.  
150 hour warranty.  
\$750.00**

Compare and you'll choose Videomax for Mark III and Mark X head rebuilding. A *Certified* Videomax-rebuilt head will actually perform better than when you bought it — on your recorders, by your own standards. That's why networks, independent stations, and major teleproduction facilities are now using Videomax. And as an extra bonus, you get the extended warranty and lower price.

Write or phone (collect) today for details about our NO-RISK trial offer.

## videomax™

Corporation—subsidiary of ORROX Corporation.

154 San Lazaro Avenue

Sunnyvale, California 94086

Phone: (408) 739-5391 Telex: 346-459

Canada: Glentronix, Ltd., Toronto

South/Central America: Telemation International/TeleMerica, Inc.



**See us at NAB Booth 500 in the Telemation International section.**

Circle 252 on Reader Service Card

[www.americanradiohistory.com](http://www.americanradiohistory.com)